

Advanced Manual

DIGITAL CAMERA

IR-300

OLYMPUS

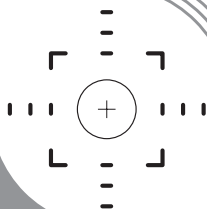
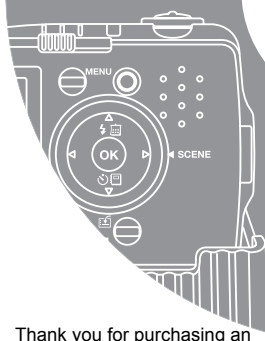

Dock&Done

- Thank you for purchasing an Olympus digital camera. Before you start to use your new camera, please read these instructions carefully to enjoy optimum performance and a longer service life. Keep this manual in a safe place for future reference.
- We recommend that you take test shots to get accustomed to your camera before taking important photographs.
- In the interest of continually improving products, Olympus reserves the right to update or modify information contained in this manual.

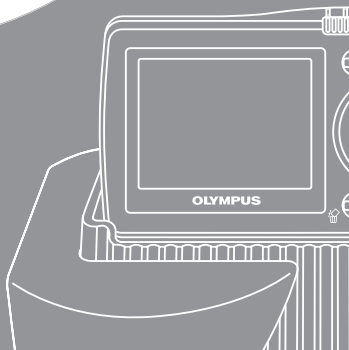

How to use this manual

● Basic and Advanced Manuals

The instruction manual accompanying this camera is divided into two parts: the Basic Manual and the Advanced Manual (this document).

Basic Manual This manual helps you get used to the camera. It gives you easy-to-follow explanations on how to take pictures and view them.

Advanced Manual This manual introduces you to the camera's many functions after you have mastered the basics. It will help you to use the camera's capabilities to take much more creative pictures, with more fun!

● Indications used in this manual

Below is an explanation of how to read the instructions in this manual. Please read it carefully before proceeding.

Note

Important information on factors which may lead to a malfunction or operational problems. Also warns of operations that should be absolutely avoided.

TIPS

Useful information and hints that will help you get the most out of your camera.



Reference pages describing details or associated information.

● Using Dock&Done

To use the camera with Dock&Done storage unit (hard disk or DVD) or Dock&Done printer, see " Dock&Done functions" in Chapter 9 (P. 104).

For details on how to operate Dock&Done hard disk storage unit, Dock&Done DVD storage unit, and Dock&Done printer, see the instruction manual for each device.

Composition of the manual

You'll find important points for getting the most out of your camera here. Read this part before taking pictures.

Explanations of techniques from basics to advanced, giving you an understanding of all the functions related to taking pictures.

To view, edit and sort the pictures you have taken.

For getting more enjoyment out of your camera.

Settings to make your camera easier to use.

When you want to use Dock&Done functions. Why not take a look at the world of new possibilities?

To print the pictures you have taken.

To enjoy the pictures you have taken on a computer. To use OLYMPUS Master.

Troubleshooting. For when you want to know the names of parts, see a list of menus, or find what you are looking for.

Basic operation P. 9

Tips before you start taking pictures P. 21

Basic shooting functions P. 31

Additional shooting functions P. 44

Additional playback functions P. 55

Creating and sharing albums P. 81

Using voice recording P. 88

Settings P. 92

Dock&Done functions P. 104

Printing pictures P. 115

Connecting the camera to a computer P. 128

Appendix P. 144

Miscellaneous P. 161

1

2

3

4

5

6

7

8

9

10









11

















12





13





The title page of each chapter gives a short description of the contents. Be sure to check it out.

Table of Contents

How to use this manual.....	2
Composition of the manual	3
1 Basic operation - - - - -	9
Mode switch	10
Direct buttons	12
Using the direct buttons	14
Menus	15
About the menus	15
Using the menus	18
How to read the procedure pages.....	20
2 Tips before you start taking pictures - - - - -	21
If the correct focus cannot be obtained.....	22
How to focus (focus lock).....	22
Subjects that are difficult to focus on	23
Record mode 	24
Still picture record modes.....	24
Movie record modes.....	25
Number of storable still pictures/remaining recording time	25
Changing the record mode.....	27
The internal memory and memory card	28
Card basics	29
Inserting and removing the card.....	29
3 Basic shooting functions- - - - -	31
Selecting a scene mode according to the situation.....	32
Using the zoom when taking pictures (Zoom/Macro).....	35
Using the zoom	35
Using the digital zoom.....	36
Using macro/super macro mode  	37
Flash shooting 	38
Recording movies 	40
Image stabilizer 	41
Fulltime AF	42
Recording sound with movies 	42
Sequential shooting 	43

4 Additional shooting functions - - - - -	44
Adjusting picture brightness 	45
Adjusting the color of a picture WB	46
Changing the area for measuring the brightness of a subject (METERING) 	47
Changing the focusing area (AF MODE)	48
Self-timer shooting 	49
Panorama shooting	50
Taking two-in-one pictures 2 IN 1	52
Shooting with a frame (FRAME MODE)	53
Recording sound with still pictures 	54
5 Additional playback functions - - - - -	55
Playing back still pictures 	56
Displaying pictures in a calendar (Calendar display)	57
Picture rotation 	58
Playing back movies 	59
Selecting the position to begin movie playback (INDEX PLAY)	60
Changing the amount of information displayed on the screen INFO	61
Slideshow 	62
Adding sound to still pictures 	64
Editing still pictures (BLACK & WHITE / SEPIA /  / )	65
Correcting pictures (REDEYE FIX / BRIGHTNESS / SATURATION)	66
Composing pictures with illustrations	68
Frame	68
Title	69
Calendar	70
Layout	71
Editing movies	73
Editing a movie	73
Creating an index	74
Playing back pictures on a TV	76
Selecting the video output	77
Protecting pictures 	77
Copying pictures in the internal memory to the card (BACKUP)	78
Erasing pictures  	79
Formatting the internal memory or a card  	80

6	Creating and sharing albums- - - - -	81
	Adding pictures to an album (ALBUM ENTRY).....	82
	Viewing pictures in albums (SEL. ALBUM).....	84
	Rearranging album pictures (REARRANGE).....	85
	Removing pictures from albums.....	86
	Undoing album entries (UNDO ENTRY / UNDO ALL).....	86
	Erasing pictures from albums.....	87
7	Using voice recording - - - - -	88
	Recording sound (VOICE REC).....	89
	Selecting the sound recording quality	90
	Turning the monitor on/off.....	90
	Playing back sound recorded with VOICE REC.....	91
8	Settings- - - - -	92
	Saving camera settings (ALL RESET).....	93
	Selecting a display language 	94
	Changing the startup screen (SCREEN).....	94
	Setting the sleep time (SLEEP).....	95
	Custom button 	96
	Setting the custom button	97
	Using the custom button	97
	Setting camera sounds	98
	Viewing pictures immediately (REC VIEW).....	99
	Resetting file names (FILE NAME).....	99
	Adjusting the monitor brightness 	100
	Setting the date and time 	101
	Resetting the camera settings (MODE RESET).....	102
	Adjusting the image processing function (PIXEL MAPPING)	103
9	Dock&Done functions- - - - -	104
	Using the camera with a Dock&Done storage unit	
	(hard disk/DVD).....	105
	Storing camera pictures (STORE ONLY).....	105
	Playing back pictures on the storage unit (STORAGE)	107
	Creating a disk for storing pictures	
	(CREATE SHARE DISK)	108
	Using the camera with a Dock&Done printer	110
	Using a Dock&Done storage unit with a	
	Dock&Done printer.....	110

Using a Dock&Done printer.....	112
Camera settings	113
Storing pictures (STORE)	113
Settings after storing (STORE AND).....	113
Printing all new pictures (NEW ALL PRINT)	114
Settings after printing (PRINT AND)	114
10 Printing pictures - - - - -	115
Direct printing (PictBridge)	116
Using the direct printing function	116
Printing pictures	117
Other print modes and print settings	120
If an error message is displayed	122
Print settings (DPOF) 	123
How to make print reservations.....	123
Single-frame reservation 	124
All-frame reservation 	126
Resetting print reservation data 	126
11 Connecting the camera to a computer - - -	128
Flow.....	129
Using OLYMPUS Master	130
What is OLYMPUS Master?.....	130
Installing OLYMPUS Master	131
Connecting the camera to a computer	135
Starting up OLYMPUS Master	136
Displaying camera images on a computer	138
Downloading and saving images	138
Viewing still pictures and movies	140
Printing pictures	141
To download and save images to a computer without using OLYMPUS Master.....	143
12 Appendix - - - - -	144
Troubleshooting	145
Error messages.....	145
Troubleshooting	147
Camera care	153
AC adapter	154
Safety Precautions	155

Glossary of terms 159

13 Miscellaneous - - - - - 161

Menu list..... 162
List of factory default settings..... 169
Modes and shooting functions 171
Names of parts..... 173
 Camera 173
 Cradle..... 175
 Monitor indications 176
Index 179

Basic operation

1

Are you ever overwhelmed by all of the advanced shooting and editing functions? Professional photographers use these functions to achieve a variety of effects. Now you too can achieve such effects simply by pressing the buttons on your digital camera. You can use the various functions available on your camera to adjust the brightness and white balance of your pictures, alter the focusing range, and much more.

Just display a menu on the monitor and use the buttons to choose a setting. Familiarize yourself with the buttons and menus before reading the explanations of the various functions.

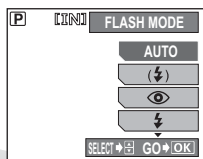
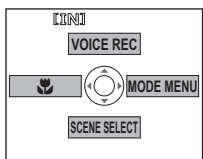

Movies





Sequential shooting

Mode switch

This camera features a shooting mode and a playback mode, which is set using the mode switch. Set the desired mode and turn the camera on.

Shooting modes

Set the mode switch to  to take still pictures or  to record movies.



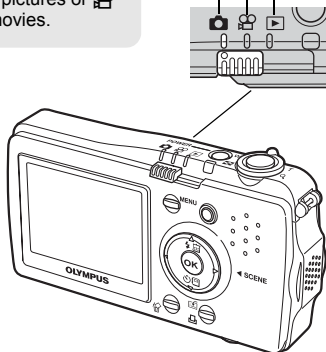

Playback mode

Set the mode switch to this position to view pictures.



● Playback modes

The playback modes are as follows. Set the mode switch to  for all modes.

- **Playback mode (normal)**  “Playing back still pictures” (P. 56)
Recorded pictures are played back one frame at a time or as thumbnails.
- **Calendar display mode**  “Displaying pictures in a calendar (Calendar display)” (P. 57)
Press  during single-frame playback of pictures in normal playback mode to view the pictures in a calendar display.
- **Album display mode**  “Viewing pictures in albums (SEL. ALBUM)” (P. 84)
Press  during single-frame playback of pictures in normal playback mode to view the pictures in an album.

? TIPS

- You can change the mode before and after turning the camera on.
- This camera also has a storage playback mode that can be used with a Dock&Done storage unit. For details on the storage playback mode, see “ Dock&Done functions” (P. 104).



Mode switch notation

In this manual, the following icons indicate the position of the mode switch necessary for operating functions.



This indicates an operation when the mode switch is set to .



This indicates an operation when the mode switch is set to any of the    modes.

Direct buttons

The direct buttons have different functions in shooting mode and in playback mode.

● Shooting mode

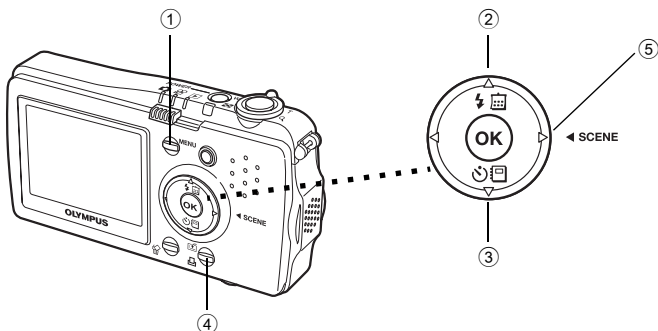

- ① **MENU** button 👉 P. 15

Displays the top menu of shooting mode

- ② **⚡** (Flash mode) button 👉 P. 38

For selecting the flash mode

- ③ **⏱** (Self-timer) button 👉 P. 49

Switches the self-timer mode on/off

- ④ **📷** (Custom) button 👉 P. 97





Sets the function assigned to the custom button

- ⑤ **◀▶ SCENE** (Scene select) button 👉 P. 32

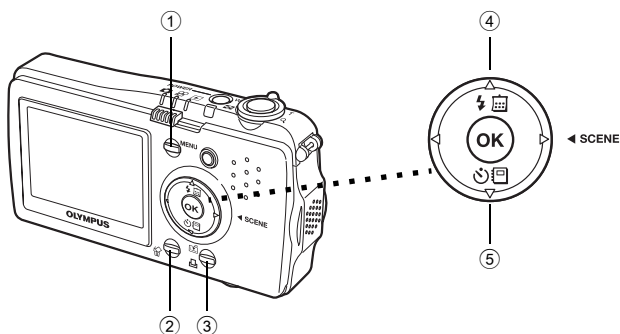
Selects a scene mode

● Playback modes



- | | | |
|---|---|---------------|
| ① | MENU button | ☞ P. 15 |
| | Displays the top menu of playback mode | |
| ② |  (Erase) button | ☞ P. 79 |
| | Erases pictures displayed on the monitor | |
| ③ |  (Print) button | ☞ P. 112, 123 |
| | Displays the top menu of the print screen | |
| ④ |  (Calendar display) button | ☞ P. 57 |
| | Enables calendar display mode | |
| ⑤ |  (Album display) button | ☞ P. 84 |
| | Enables album display mode | |

Using the direct buttons

Basic functions can be easily operated using direct buttons. Use the arrow pad and \odot to adjust settings. Follow the on-screen display to select and adjust each setting. How to set the flash mode using $\Delta \text{⚡}$ is shown below.

1 Set the mode switch to Ⓜ , and press $\Delta \text{⚡}$.

- The flash mode selection screen is displayed.

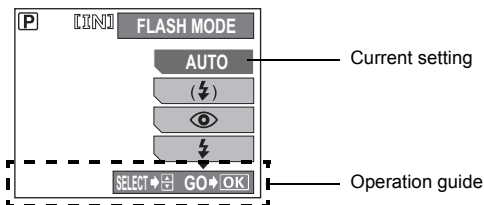

SELECT → Press $\Delta \nabla$ to select the setting.
GO → Press \odot to commit your selection.

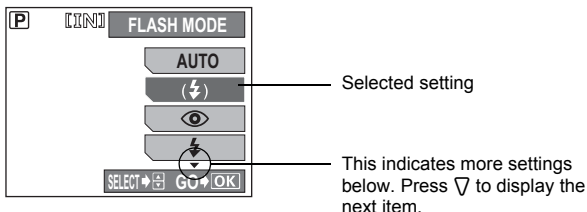

2 Press $\Delta \nabla$ to select the flash mode.



3 Press \odot .

- The setting is made, and the menu closes.

Menus

Set the mode switch to   , and press the **MENU** button to display the menus on the monitor. Menus are used to make all camera settings.

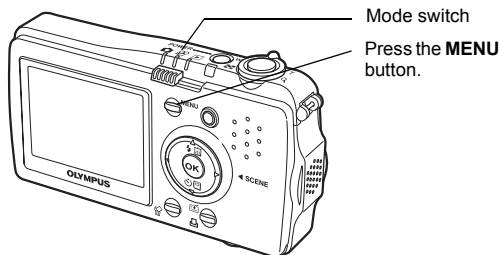

About the menus

The menu items displayed in shooting mode and playback mode differ.

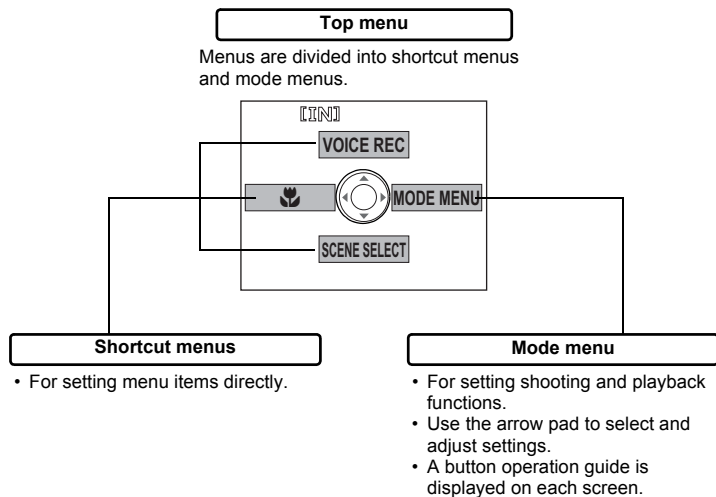

Shortcut menus

Mode Switch

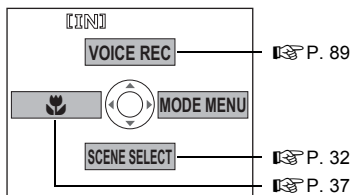

Mode Switch

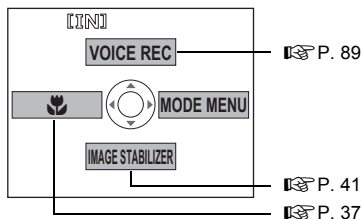

Mode Switch



Menu options will vary with each mode.

Still picture

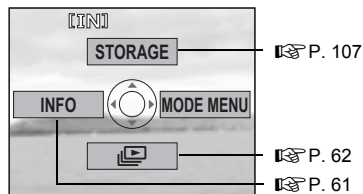

Movie

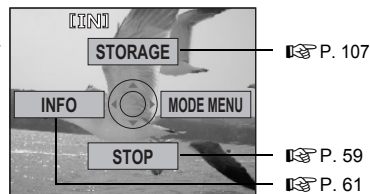

Voice playback

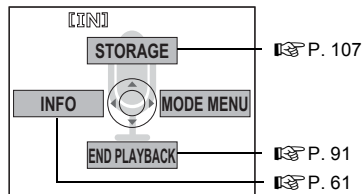

Calendar display

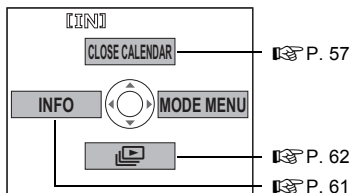

Album display

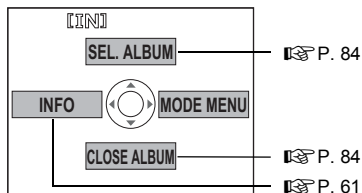

Mode menus

In addition to the following mode menus, there are also mode menus for movie playback and calendar display. For details, see "Menu list" (P. 162).

Mode
Switch

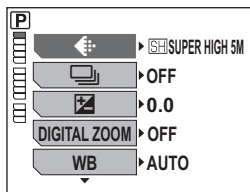

Mode
Switch

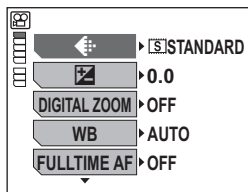

Mode
Switch

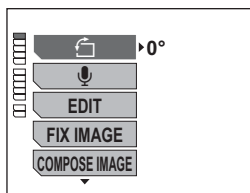

Using the menu

Use the arrow pad and  to select and set the menu items.

Follow the operation guide and arrows on the screen to select and change settings. This section explains how to use the menus.

Ex: Setting [METERING]

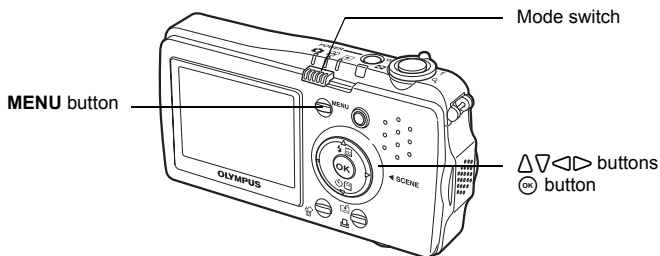

1 Set the mode switch to .

2 Press the MENU button.

- The top menu is displayed.

3 Press ▶ to select [MODE MENU].

This refers to the arrow pad (△▽◀▶).

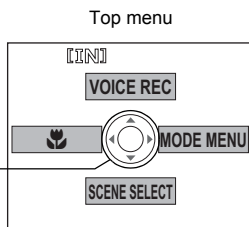

4 Press △▽ to select [METERING], and press ▶.

- Refer to the arrows on the screen to select a setting with the arrow pad.
- Unavailable settings cannot be selected.

The selected item is displayed in a different color.

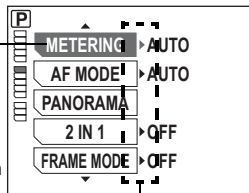

Press ▶ to go on to the following setting.

5 Press Δ / ∇ to select [AUTO] or [●], and press OK .

- Press the **MENU** button to close the menu.

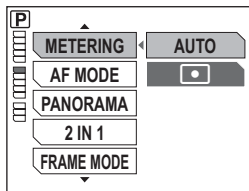

? TIPS

- Common menu items can be adjusted from any mode, and the settings will apply respectively.

Menu operation notation

In this manual, procedures for using the menus are expressed as follows:

- Ex: Steps 1 to 5 for setting [METERING]



Top menu ▶ [MODE MENU] ▶ [METERING] ▶ [AUTO] / [●]

How to read the procedure pages

1 Basic operation

A sample of a procedure page is shown below explaining the notation. Look at it carefully before taking or viewing pictures.

This indicates the position of the mode switch.

If multiple mode switch icons are displayed, the described function can be used in any of these modes.

 “Mode switch” (P. 10), “Mode switch notation” (P. 11)

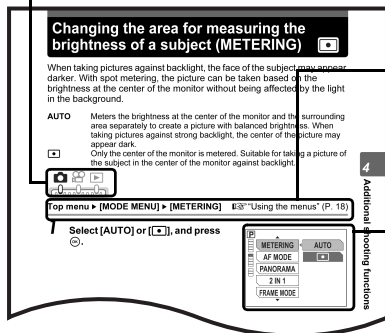



Select the menus in the order indicated by ►.  “Using the menus” (P. 18), “Menu operation notation” (P. 19)

Available languages vary depending on the area where you purchased this camera.  “Selecting a display language” (P. 94)

This sample page is only for your reference. It may differ from the actual page in this manual.

Tips before you start taking pictures

2

Your pictures are almost guaranteed to come out well just by setting the mode switch to  or  and pressing the shutter button. But occasionally, you can't focus on your subject, the subject is too dark, or the picture doesn't come out the way you want...

Just knowing which button to press or which setting to change can help you solve these problems.

And did you know that by selecting an image size according to how you plan to use the pictures afterwards, you can store more pictures on the memory card? These are just some of the hints provided in this chapter.

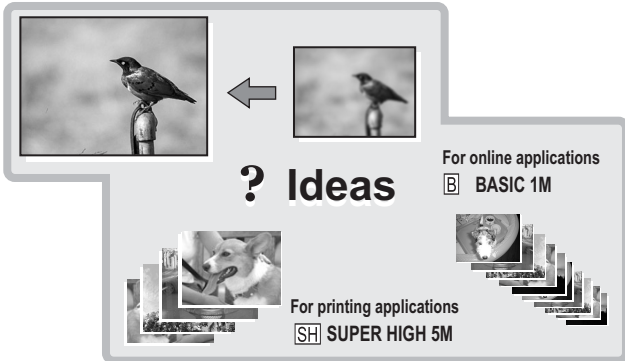

? Ideas

For online applications
B BASIC 1M

For printing applications
SH SUPER HIGH 5M

If the correct focus cannot be obtained

The camera automatically detects the focus target in the frame. The level of contrast is one of the criteria used to determine the subject. The camera may fail to determine subjects with lower contrast than the surroundings or with an area of extremely strong contrast in the frame. If this happens, the simplest solution is to use the focus lock.

How to focus (focus lock)

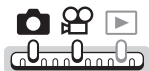

1 Position the AF target mark on the subject you want to focus on.

- When shooting a hard-to-focus or fast-moving subject, focus the camera on an object about the same distance away as the subject.

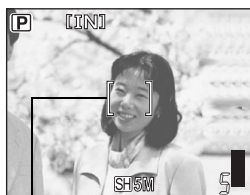

AF target mark

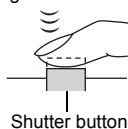

2 Press the shutter button halfway until the green lamp lights.

- When the focus and exposure are locked, the green lamp lights.
- When the green lamp blinks, the focus and exposure are not locked. Release your finger from the shutter button, reposition the AF target mark on the subject and press the shutter button halfway again.

3 Keeping the shutter button pressed halfway, recompose your shot.

Green lamp



4 Press the shutter button fully.

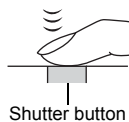

? TIPS

Focus on the subject in the center of the frame.

☞ “Changing the focusing area (AF MODE)” (P. 48)

Subjects that are difficult to focus on

Under certain types of conditions, the auto focus may not work properly.

The green lamp blinks.
The subject cannot be brought into focus.



Subject with low contrast



Subject with an extremely bright area in the center of the frame

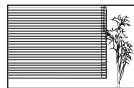

Subject without vertical lines

The green lamp lights,
but the subject cannot be brought into focus.



Subjects at different distances

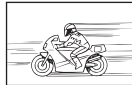

Fast-moving subject



The subject is not in the center of the frame

In these cases, focus (focus lock) on an object with high contrast at the same distance as the intended subject, recompose your shot and then take the picture. If the subject has no vertical lines, hold the camera vertically and focus the camera using the focus lock function by pressing the shutter button halfway, then return the camera to the horizontal position while keeping the button pressed halfway and take the picture.



You can select a record mode in which to take pictures or shoot movies. Select the best record mode for your purpose (printing, editing on a computer, website editing, etc.). For information on the image sizes for each record mode and the number of storable still pictures/movie recording time, see the table on P. 25.

Still picture record modes

Record mode depicts the image size of pictures.

Pictures are made from thousands of dots (pixels). If a picture with relatively few pixels is enlarged, it looks like a mosaic. Pictures with more pixels are denser and clearer but require more space (larger file size), thus decreasing the number of pictures that can be saved.

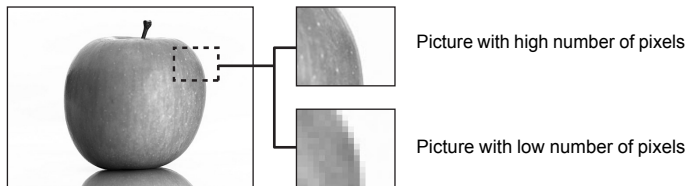

Record mode	Image size	Application
[SH] SUPER HIGH 5M	2560 × 1920	The number of storable still pictures is lower, and it takes longer to record pictures, but it is useful for creating beautiful prints on full-size paper and performing image processing, such as contrast adjustment and red-eye correction, on a computer.
[H1] HIGH 3M	2048 × 1536	
[H2] HIGH 2M	1600 × 1200	Use this setting to create postcard-size prints. This is also useful for adding text to a picture, rotating a picture, or performing other editing with a computer.
[B] BASIC 1M	1024 × 768	The record mode is normal for a smaller image size but a greater number of storable still pictures. This is useful for viewing pictures on a computer.
[E] E-MAIL VGA	640 × 480	The record mode is normal for a smaller image size that is convenient for attaching to e-mail.

Image size

The number of pixels (horizontal × vertical) used when saving an image. You can save your pictures at a large image size to get clearer prints. However, as the image size increases, the file size (data size) also increases, which decreases the number of pictures that can be saved.

Movie record modes

Movies are recorded in Motion-JPEG format.

[S]STANDARD offers an easy-to-see image size, but the recording time is short.

[E]EXTENDED offers longer recording time, but the picture may appear grainy.

Number of storable still pictures/remaining recording time

Still pictures

Record mode	Image size	Number of storable still pictures			
		Internal memory		Using a 32 MB card	
		With sound	Without sound	With sound	Without sound
[SH]SUPER HIGH 5M	2560 × 1920	10	10	25	26
[H1]HIGH 3M	2048 × 1536	15	16	39	41
[H2]HIGH 2M	1600 × 1200	23	25	60	64
[B]BASIC 1M	1024 × 768	41	45	104	117
[X]E-MAIL VGA	640 × 480	86	111	221	284

Movies

Record mode	Image size	Remaining recording time (sec.)			
		Internal memory		Using a 32 MB card	
		With sound	Without sound	With sound	Without sound
[S]STANDARD	320 × 240 (15 frames/sec.)	36	37	93	96
[E]EXTENDED	160 × 120 (15 frames/sec.)	146	166	374	424

? TIPS

- When a picture is transferred to a computer, the size of the picture on the computer screen varies depending on the computer's monitor setting. For instance, a picture taken with an image size of $1,024 \times 768$ fills the screen if you set the picture to $1\times$ when the monitor setting is $1,024 \times 768$. However, if the monitor setting is over $1,024 \times 768$ (such as $1,280 \times 1,024$), the picture only takes up part of the screen.

! Note

- The number of storable still pictures and remaining recording time listed in the tables are approximate.



Number of storable still pictures



Remaining recording time

- The number of storable still pictures may change according to the subject or factors like whether print reservations or album entries have been made or not. In certain instances, the number of remaining pictures does not change even when you take pictures or stored images are erased.

Changing the record mode



Top menu ▶ [MODE MENU] ▶ [◀⏪]

☞ “Using the menus” (P. 18)

- 1 Select a record mode from [SH] SUPER HIGH 5M], [H1] HIGH 3M], [H2] HIGH 2M], [B] BASIC 1M] and [X] E-MAIL VGA].

For movies, select a record mode from [S] STANDARD] and [E] EXTENDED].

- 2 Press .

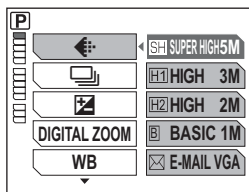

For still pictures

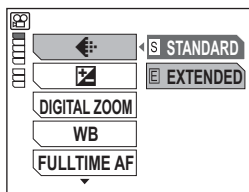

For movies

2

Tips before you start taking pictures

The internal memory and memory card

Pictures taken are recorded in the internal memory.

Pictures can also be recorded to an xD-Picture Card (“card”), sold separately. The card can be used to record more pictures than is possible with the internal memory of the camera. A card can be convenient when taking many pictures while on a trip.

● Internal memory basics

The internal memory is the camera’s media for recording pictures, similar to film in a film camera.

Pictures recorded to the internal memory can be easily erased on the camera or processed using a computer. Unlike portable storage media, the internal memory cannot be removed or exchanged.

● Using the internal memory with a card

You can confirm on the monitor whether the internal memory or card is being used during shooting and playback operations.



Memory indicator

Monitor indication	Shooting mode	Playback mode
[IN]	Pictures are recorded to the internal memory.	Pictures are being played back from the internal memory.
[xD]	Pictures are recorded to a card.	Pictures are being played back from a card.

- The internal memory and a card cannot be used at the same time.
- The internal memory cannot be used for shooting or playback operations when a card is inserted in the camera. Remove the card before using the internal memory.
- Pictures recorded to the internal memory can be copied to a card. “Copying pictures in the internal memory to the card (BACKUP)” (P. 78)

Card basics

The card is a medium for recording pictures, similar to film in a film camera. Pictures recorded to the card can be easily erased on the camera or processed using a computer. The number of recordable images can be increased by exchanging the card for one with a larger capacity.

- ① Index area
You can use this space to write the contents of the card.
- ② Contact area
The part where the data transferred from the camera enters the card.

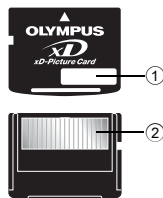

Compatible cards

xD-Picture Card (16 – 512 MB)

! Note

- This camera may not recognize a non-OLYMPUS card or a card that was formatted on another device (such as a computer, etc.). Before use, be sure to format the card on this camera. “Formatting the internal memory or a card” (P. 80)

Inserting and removing the card

1 Make sure the camera is turned off.

- The power lamp is off.
- The monitor is off.
- The lens barrier is closed.

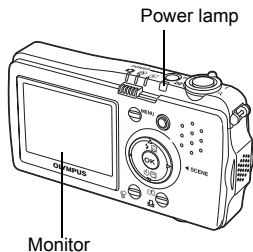

2 Open the battery compartment/ card cover.

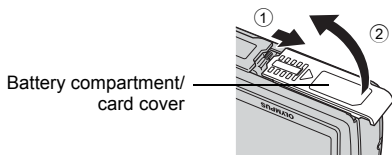

● Inserting the card

3 Orient the card as shown, and insert it into the card slot as shown in the illustration.

- Insert the card straight in.
- Insert the card until it clicks into place.
- Inserting the card in the wrong direction or at an angle may damage the contacts and prevent the card from being removed.
- The card may not record properly if it is not inserted all the way in.

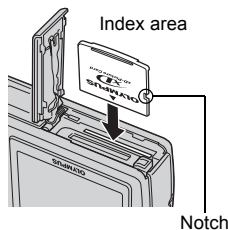

● Removing the card

3 Push the card all the way in and release slowly.

- The card protrudes slightly and stops.

Caution

Releasing your finger quickly after pushing the card all the way in may cause it to eject forcefully out of the slot.

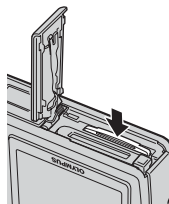

- Grasp the card and remove.

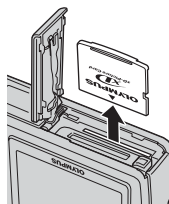

4 Close the battery compartment/ card cover.

Basic shooting functions

3

A professional photographer adjusts the exposure to the optimal setting, chooses the best focusing method and even selects the type of film according to the subject. With a digital camera, you don't need to learn how to make difficult settings. Your camera will adjust the settings for you! All you have to do is choose a scene mode according to whether you are taking a landscape, a night scene, a portrait-style image or whatever, and the camera will set the best exposure and white balance. There's nothing to it – just press the shutter button!

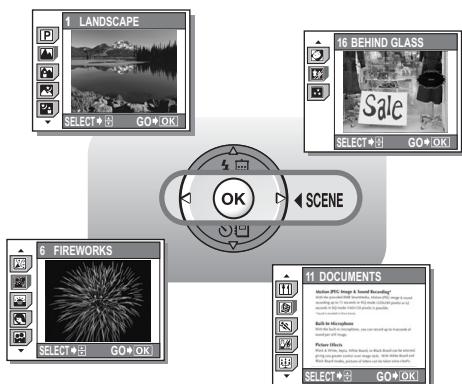

Selecting a scene mode according to the situation

When you select a scene mode according to the shooting scene or conditions, the camera automatically selects the optimal settings.

● SCENE mode

P-AUTO (Program Auto)

Suitable for general situations. The camera automatically adjusts to the subject.

Landscape

Suitable for taking pictures of landscapes and other outdoor scenes. Blues and greens are vividly reproduced.

Landscape+Portrait

Suitable for taking pictures of your subject against a distant background. Blues, greens, and skin tones are vividly reproduced.

Night Scene*

Suitable for taking pictures in the evening or at night. The camera sets a slower shutter speed than is used in normal shooting.
Since the shutter speed is slow, stabilize the camera before taking pictures.

Night+Portrait*

Suitable for taking pictures of your subject against a distant night scene. The camera sets a slower shutter speed than is used in normal shooting.
Since the shutter speed is slow, stabilize the camera before taking pictures.

Indoor

Suitable for taking pictures of people indoors. The atmosphere of the background is also vividly reproduced.

Fireworks*

Suitable for taking pictures of fireworks displays. The camera sets a slower shutter speed than is used in normal shooting.
Since the shutter speed is slow, stabilize the camera before taking pictures.

Sunset*

Suitable for taking pictures of the evening sunlight. Reds and yellows are vividly reproduced.

Since the flash is not available, stabilize the camera before taking pictures.

Portrait

Suitable for taking portrait pictures. This mode accentuates the skin texture of the portrait subject.

Self Portrait

Suitable for taking self-portrait pictures.

Cuisine

Suitable for taking pictures of food. Food colors are vibrantly reproduced.

Documents

Suitable for taking pictures of documents or time schedules. The contrast between the text and background is enhanced.

Since the flash is not available, stabilize the camera before taking pictures.

Sports

Suitable for capturing fast-moving action. Even fast-moving subjects appear to be stationary.

Beach & Snow

Suitable for taking pictures on a sunny day at the beach or in the snow. You can take pictures of your subject against a beautiful sky or landscape.

Candle*

Suitable for capturing the atmosphere of a candle-lit scene. Warm colors are reproduced.

Since the flash is not available, stabilize the camera before taking pictures.

Available Light Portrait*

Suitable for shooting subjects in low light conditions without a flash. Since the flash is not available, stabilize the camera before taking pictures.

Behind Glass

Suitable for shooting a subject through glass.



Vivid

Vividly reproduces all colors. This mode can be used independently of the P-AUTO (Program Auto) which produces natural colors.

* Noise reduction is automatically enabled when the subject is dark. Processing time between shots is doubled and you cannot take pictures during this time. Also, the image file size is slightly larger than normal.



1 Press SCENE.

-  “Direct buttons” (P. 12)
- The scene mode selection screen is displayed.
- You can also press  to display this screen.

2 Press to select a scene mode, and press .

- When you choose a scene mode, a sample scene is displayed.

3 Take the picture.

TIPS

- You can also select a scene mode by pressing the **MENU** button to display the top menu and selecting [SCENE SELECT].

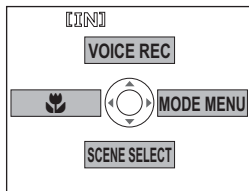
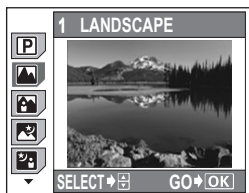

Using the zoom when taking pictures (Zoom/Macro)

You can zoom in on your subject using the optical zoom and digital zoom. With the optical zoom, the image is enlarged for the CCD when the lens magnification is changed, and the image is formed by all the CCD pixels. With the digital zoom, the area at the center of the image captured by the CCD is cropped and enlarged. When you digitally zoom in on a subject, you are essentially taking a small area of the picture and making it bigger. Therefore, the greater the magnification with the digital zoom, the grainier the resulting picture will be.

The following zoom magnifications are available on this camera.

Optical zoom 3× (equivalent to 38 mm to 114 mm on a 35 mm camera)

Optical zoom + digital zoom Max. 12×

Note that camera movement is amplified at higher magnifications.

Using the zoom



1 Push or pull the zoom lever.

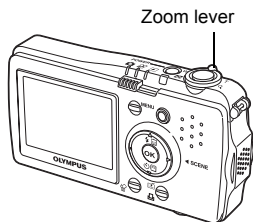

Zoom out:
Push the zoom lever toward W.



Zoom in:
Pull the zoom lever toward T.



! Note

- You can use the optical zoom in mode by setting [M] to [OFF].
 "Recording sound with movies" (P. 42)

Using the digital zoom



Top menu ▶ [MODE MENU] ▶ [DIGITAL ZOOM] ▶ [ON] / [OFF]

☞ “Using the menus” (P. 18)

1 Pull the zoom lever toward T.

Optical zoom

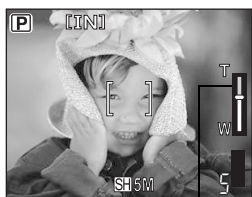

The white area of the zoom indicator indicates the optical zoom. If the [DIGITAL ZOOM] is set to [ON], a red area is displayed on the zoom indicator. When you reach the limit of the optical zoom, the digital zoom is enabled.

Digital zoom

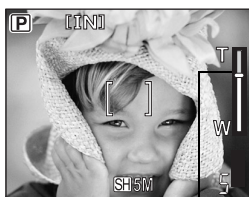

The cursor moves up and down the zoom indicator according to the zoom magnification. The cursor turns orange when inside the digital zoom area.

! Note

- Taking a picture with the digital zoom may cause the picture to appear grainy.

Using macro/super macro mode



Focusing is usually slow when you get close to a subject (W: 10 cm/3.9" to 30 cm/11.8", T: 50 cm/19.7" to 60 cm/23.6"). However, in macro mode focusing is performed quickly.



This mode lets you shoot from as close as 10 cm/3.9" to your subject.



This mode lets you shoot from as close as 5 cm/1.9" to your subject. In this mode, normal shooting is also possible, but the magnification of the zoom is fixed automatically and cannot be changed.



Top menu ▶ [Macro]

☞ "Using the menus" (P. 18)

1 Select [Macro] or [Super Macro], and press **OK**.

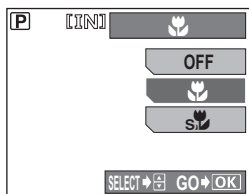

2 Take the picture.

! Note

- During super macro shooting, the zoom and flash are not available.



Select the flash mode best suited to the light conditions and the effect you want to achieve. You can also adjust the amount of light emitted using the flash intensity control.

Flash working range

W (max.): Approx. 30 cm to 2.6 m (1.0 ft. to 8.5 ft.)

T (max.): Approx. 50 cm to 2.1 m (1.6 ft. to 6.9 ft.)

Auto-flash (No indication)

The flash fires automatically in low light or backlight conditions.

Soft flash ((⚡))

A less intense flash. Use when auto-flash or fill-in flash are too bright.

Red-eye reduction flash (👁)

The light from the flash may make the subject's eyes appear red in the picture. The red-eye reduction flash mode reduces this phenomenon by emitting pre-flashes before firing the regular flash.



The subject's eyes appear red.

! Note

- After the pre-flashes, it takes about 1 second before the shutter is released. Do your best to hold the camera steady throughout the shot.
- Effectiveness may be limited if the subject is not looking directly at the pre-flashes, or if the shooting range is too far. Individual physical characteristics may also limit effectiveness.

Fill-in flash (⚡)

The flash fires regardless of the available light. This mode is useful for eliminating shadows on the subject's face (such as shadows from tree leaves), in a backlight situation, or for correcting the color shift produced by artificial lighting (especially fluorescent light).



! Note

- The fill-in flash may not have the desired effect under excessively bright light.

Flash off (⚡)

The flash does not fire even in low light conditions. Use this mode in situations where flash photography is not desired or is prohibited. You can also use this mode when shooting landscapes, sunsets, and other subjects outside the range of the flash.

! Note

- Since a slow shutter speed is automatically selected in low light situations when in the flash off mode, the use of a tripod is recommended to prevent your pictures from being blurred by camera movement.



- 1 Press Δ ⚡.
- 2 Select a flash mode, and press \odot .

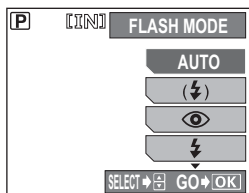

- 3 Press the shutter button halfway.
 - In conditions where the flash will fire, ⚡ lights (flash stand-by).
- 4 Press the shutter button fully to take the picture.



? TIPS

The ⚡ (flash charge) mark blinks.

→ The flash is charging. Wait until ⚡ turns off.

Note

- The flash does not fire in the following situations:
During sequential shooting, super macro, panorama, or when **SCENE** is set to [] , [] , [] , or [] .
- The flash may not give you the optimum result in macro mode with the zoom set to wide-angle (W). Check the resulting picture on the monitor.

Recording movies



This function allows you to record movies.



1 Compose your picture.

- The remaining recording time is displayed on the monitor.
- You can use the zoom lever to enlarge your subject.



Remaining recording time

2 Press the shutter button fully to start recording.

- Audio is recorded with the movie.
- The self-timer/card access lamp blinks while the movie is being saved.
- During movie recording, [] lights red.



3 Press the shutter button again to stop recording.

- When the remaining recording time has been used up, recording stops automatically.
- When there is space in the internal memory or the card, the remaining recording time (P. 25) is displayed, and the camera is ready to shoot.

? TIPS**To keep the subject in focus all the time during movie recording**

→ Set [M] to [OFF] and [FULLTIME AF] to [ON]. “Fulltime AF” (P. 42),
 “Recording sound with movies” (P. 42)

To use the zoom during movie recording

→ Set [DIGITAL ZOOM] to [ON]. “Using the digital zoom” (P. 36)
 → If you set [M] to [OFF], you can use the optical zoom during movie recording.
 “Recording sound with movies” (P. 42)

! Note

- The remaining recording time may drop rapidly during recording. Try using the internal memory or card again after formatting it with your camera.
 “Formatting the internal memory or a card” (P. 80)
- In mode, the flash is not available.

Image stabilizer

This function can be used to reduce blurred pictures resulting from camera movement during movie recording.

The area in which the picture is captured by the CCD is adjusted according to movement of the subject, thereby enabling recording of the picture with reduced blurring of the subject. When [IMAGE STABILIZER] is set to [ON], a slightly enlarged picture is recorded.



Top menu ▶ [IMAGE STABILIZER] ▶ [ON] / [OFF]

“Using the menus” (P. 18)

1 Take the picture.

Displayed during
image stabilization.

**! Note**

- Image stabilizer may not work depending on the movement of the subject or if there is a large amount of camera movement.
- Set [IMAGE STABILIZER] to [OFF] when stabilizing the camera with a tripod or other device because the image may move in response to the movement of the subject.

Fulltime AF

When [FULLTIME AF] is set to [ON], the subject is automatically kept in focus during movie recording.



Top menu ▶ [MODE MENU] ▶ [FULLTIME AF] ▶ [ON] / [OFF]

"Using the menus" (P. 18)

! Note

- Fulltime AF consumes more battery power.
- Fulltime AF cannot be used when [AF] is set to [ON].

Recording sound with movies



Sound can be recorded while shooting a movie.



Top menu ▶ [MODE MENU] ▶ [AF] ▶ [ON] / [OFF]

"Using the menus" (P. 18)

! Note

- When [AF] is set to [ON], the focus and optical zoom are locked during movie recording. If you wish to use the zoom during movie recording, set [DIGITAL ZOOM] to [ON]. If [AF] is set to [OFF], you can use both the optical zoom and digital zoom during movie recording.
- If the microphone is farther than 1 m (3.3 ft.) from the subject, sound may not be recorded properly.



You can take a sequence of pictures at one time. The focus, exposure and white balance are locked at the first frame. When the record mode is set to [SH] SUPER HIGH 5M, for example, you can take a sequence of approximately 4 pictures.



Top menu ▶ [MODE MENU] ▶ [] ▶ [ON] / [OFF]

▶ “Using the menus” (P. 18)

1 Take the picture.

- Press the shutter button fully and keep it pressed. The camera will take pictures in sequence until you release the button.

! Note

- Sequential shooting is not possible in the following situations:
During panorama, two-in-one pictures, shooting with a frame, or when SCENE is set to [P], [S], [L], [M], [H], or [A].
- During sequential shooting, the flash is not available.
- If the battery power is low and the battery check indication blinks during sequential shooting, shooting stops and the camera starts saving the pictures you have taken. Whether or not all of the shots are saved depends on how much battery power remains.

4

Additional shooting functions

Taking pictures like a pro...

Adjust the brightness or white balance of the picture, change the focusing area depending on the subject, and make use of other useful functions to create professional-like pictures.

At scenic outdoor sites...

Use panorama mode to capture a beautiful mountain range or impressive building.

At a party or family gathering...

Use the self-timer to take group photos at school reunions or birthday parties.

When you want to add a special effect...

Combine two pictures together to create a single picture, add a frame to a picture, and create other interesting effects.



Adjusting picture brightness



This function allows you to make fine changes to the exposure setting. You can adjust the exposure in the range of ± 2.0 EV in 1/2 EV steps. When the setting is changed, you can check the result on the monitor.

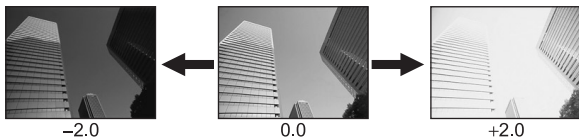

Top menu ▶ [MODE MENU] ▶ []

☞ “Using the menus” (P. 18)

1 Press Δ / ∇ to adjust the exposure, and press \odot .

- Adjust toward [+] to brighten the image or [-] to darken the image.

2 Take the picture.

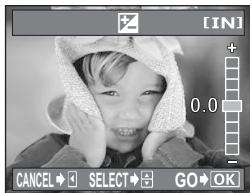

? TIPS

- Often bright subjects (such as snow) will turn out darker than their natural colors. Adjusting toward [+] makes these subjects closer to their real shades. To prevent the picture from getting brighter, adjust toward [-] when shooting dark subjects.
- In some situations, you may get better results when the exposure that the camera sets is compensated (adjusted) manually.

! Note

- If the flash is used, the image brightness (exposure) may differ from the intended brightness.
- Exposure compensation cannot correct the image if the surroundings of the subject are extremely bright or dark.

The color of the subject differs depending on the light conditions. For instance, when daylight, the setting sun or tungsten lighting are reflected on white paper, the shade of white produced will be slightly different for each. By setting the WB (white balance), you can achieve more natural-looking colors.

AUTO

The white balance is adjusted automatically so that colors look natural irrespective of the light source.



For natural colors under a clear sky.



For natural colors under a cloudy sky.



For natural colors under tungsten lighting.



For natural colors under fluorescent lighting.

4
Additional shooting functions

Top menu ▶ [MODE MENU] ▶ [WB]

“Using the menus” (P. 18)

1 Select a white balance setting, and press .

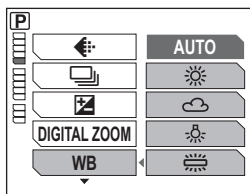

TIPS

- You can select a white balance setting other than the actual light source, and enjoy the different color tones on the monitor.

Note

- White balance may not be effective under some special light sources.
- After setting a white balance other than [AUTO], play back the picture and check the colors on the monitor.
- When the flash is fired with a white balance setting other than [AUTO], colors may appear different in the resulting picture from the colors you see on the monitor.

Changing the area for measuring the brightness of a subject (METERING)



When taking pictures against backlight, the face of the subject may appear darker. With spot metering, the picture can be taken based on the brightness at the center of the monitor without being affected by the light in the background.

AUTO Meters the brightness at the center of the monitor and the surrounding area separately to create a picture with balanced brightness. When taking pictures against strong backlight, the center of the picture may appear dark.

 Only the center of the monitor is metered. Suitable for taking a picture of the subject in the center of the monitor against backlight.



Top menu ▶ [MODE MENU] ▶ [METERING]  "Using the menus" (P. 18)

1 Select [AUTO] or , and press

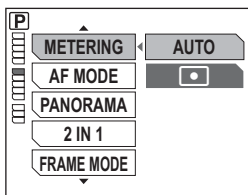

Changing the focusing area (AF MODE)

This function allows you to select how the camera focuses on your subject.

AUTO Focus selection is based on the entire picture on the screen. Even when the subject is not in the center of the screen, focusing is possible.

SPOT Focus selection is based on the subject within the AF target mark.



Subject suitable for [AUTO]

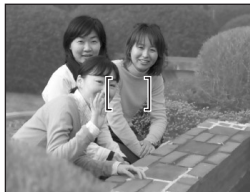

Subject suitable for [SPOT]



Top menu ▶ [MODE MENU] ▶ [AF MODE]

☞ “Using the menus” (P. 18)

- 1 Select [AUTO] or [SPOT], and press **OK**.

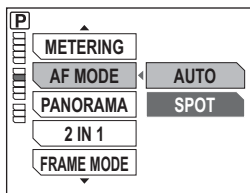

Self-timer shooting



This function lets you take pictures using the self-timer. Fix the camera securely on a tripod for self-timer shooting. This function is useful for taking pictures when you want to be included in the photograph.



- 1** Press ∇ .
- 2** Select [ON], and press .

- 3** Press the shutter button fully to take the picture.

- Pressing the shutter button halfway locks the focus and exposure.
- The self-timer/card access lamp lights for approximately 10 seconds, then starts blinking. After blinking for approximately 2 seconds, the picture is taken.
- To stop shooting while in mode, press the shutter button fully again.
- To cancel the self-timer, press ∇ .
- The self-timer mode is automatically canceled after one shot.

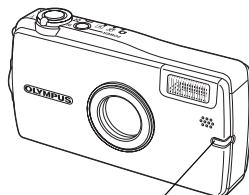
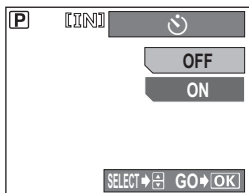

Self-timer/card access lamp

Note

- If sequential shooting is attempted in self-timer mode, the camera shoots 5 frames at most regardless of the setting.

Panorama shooting

You can take advantage of panorama shooting with an Olympus xD-Picture Card. Panorama shooting lets you connect pictures with overlapping edges into a single panoramic picture, using the OLYMPUS Master software.

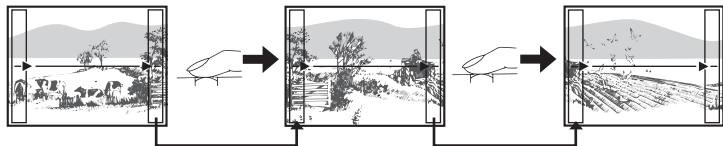

The part of the previous picture where it will be joined to the next picture does not remain in the frame on the edge of the screen. You have to remember what the part in the frame looked like and take the next picture so it overlaps. Compose your shots so that the right edge of the previous picture overlaps with the left edge of the next picture if you are connecting pictures from left to right (or vice versa if you are connecting pictures from right to left).



Top menu ▶ [MODE MENU] ▶ [PANORAMA] ⓘ “Using the menus” (P. 18)

1 Use the arrow pad to choose at which edge you want to connect the pictures.

- ▷ : The next picture is connected at the right edge.
- ◁ : The next picture is connected at the left edge.
- △ : The next picture is connected at the top.
- ▽ : The next picture is connected at the bottom.

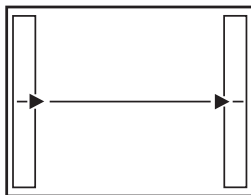

Connects pictures from left to right

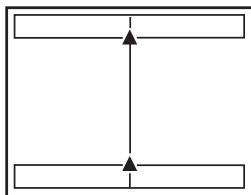

Connects pictures from bottom to top

2 Make sure that the edges of the pictures overlap, then take the pictures.

- The focus, exposure and white balance are set by the first picture. Do not select an extremely bright subject (such as the sun) for the first picture.
- You cannot adjust the zoom after the first picture.
- Panorama shooting is possible for up to 10 pictures.
- When you have taken 10 pictures, a warning mark [P1] is displayed.



3 Press **OK** to exit panorama shooting.

! Note

- Panorama mode is only available with Olympus cards.
- During panorama shooting, the flash, self-timer, sequential shooting modes and recording sound with still pictures are not available.
- The camera itself cannot connect panorama pictures. The OLYMPUS Master software is necessary to connect the pictures.

This function allows you to combine two pictures taken in succession and save them as a single picture. This way you can enjoy having two subjects in one picture.



Picture when played back

4

Additional shooting functions

Top menu ▶ [MODE MENU] ▶ [2 IN 1]

☞ “Using the menus” (P. 18)

1 Take the first picture while viewing the monitor.

- The subject is positioned on the left in the combined picture.



2 Take the second picture.

- The subject is positioned on the right in the combined picture.
- The [BUSY] bar is displayed and after the image is saved, the camera returns to the shooting mode.

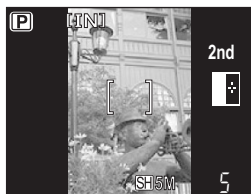

Picture when taken

! Note

- Panorama, sequential shooting, and recording sound with pictures are not available during two-in-one picture shooting.
- To cancel two-in-one picture shooting after the first picture has been taken, press **OK**. The first picture will not be saved.
- If the camera enters sleep mode after the first picture, two-in-one picture shooting will be canceled.

Shooting with a frame (FRAME MODE)

This function allows you to add one of several frames when taking a picture. The frame and picture are combined together and saved.



Top menu ▶ [MODE MENU] ▶ [FRAME MODE]

“Using the menus” (P. 18)

1 Select a frame, and press .

- The selected frame is displayed and you can take a picture with the added frame.

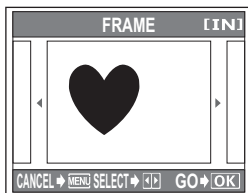

2 Take the picture.

- After you take a picture, the combined picture with selected frame is displayed. Take the picture again if the result is unsatisfactory.



3 Press .

- [FRAME MODE] ends.

Note

- Sequential shooting and recording sound with pictures are not available during shooting with a frame.

4

Additional shooting functions

Recording sound with still pictures



Sound can be recorded when taking still pictures. Recording starts about 0.5 seconds after the shutter is released and lasts about 4 seconds. When this function is enabled, sound is recorded automatically every time you take a picture.



Top menu ▶ [MODE MENU] ▶ [🎤] ▶ [ON] / [OFF]

👉 “Using the menus” (P. 18)

1 Take the picture.

- When recording starts, aim the camera microphone at the source of the sound you want to record.

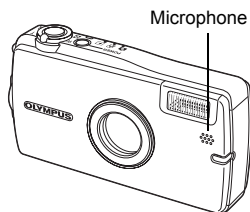

? TIPS

- [🎵] is displayed when still pictures and movies with sound are played back. During playback, sound is output from the speaker. The volume can be adjusted. 👉 “Setting camera sounds” (P. 98)
- Sound can be added later to still pictures. Recorded sound can also be re-recorded. 👉 “Adding sound to still pictures” (P. 64)

! Note

- If the microphone is farther than 1 m (3.3 ft.) from the subject, sound may not be recorded properly.
- Pictures cannot be taken during sound recording.
- Sound recording is not possible in the following cases:
 - During sequential shooting, panorama, two-in-one pictures, and shooting with a frame.
- Sound recording may also pick up camera noises, such as button operations, shutter movement, etc.
- Sound recording may not be possible if there is insufficient space in the internal memory or the card.

Additional playback functions

5

With film-type cameras, you cannot see the pictures you have taken until the film has been developed. And aren't you sometimes disappointed with the results when you do eventually see them? Pictures of blurred scenery or someone with their eyes shut. Or maybe you took several pictures of the same scene because you weren't sure whether they would come out or not. That's no way to record important memories! With a digital camera, you can review your pictures immediately. Just play the picture back as soon as you've taken it. If you don't like what you see, erase and take it again. So don't be afraid of pictures not coming out well – just keep on pressing that shutter button!

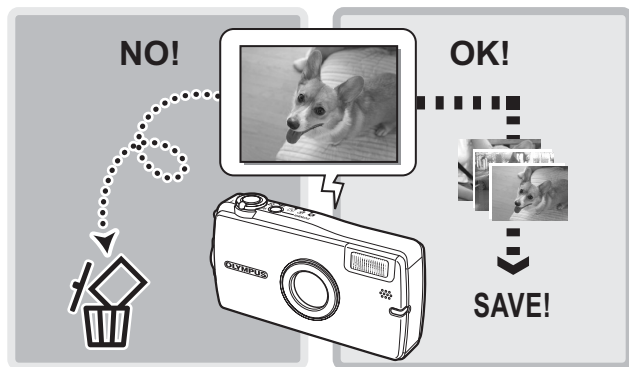

Playing back still pictures



The pictures on a card are played back if a card is inserted in the camera. Remove the card to play back pictures stored in the internal memory.



- The last picture taken is displayed on the monitor (single-frame playback).
- Use the arrow pad to browse the pictures.

1 Push or pull the zoom lever toward W or T.

- You can view the pictures close up (close-up playback) or as a thumbnail (index display).

Pull the lever toward T to return to single-frame playback.



Push the lever toward W to return to single-frame playback.

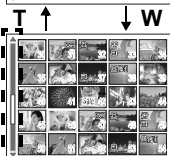
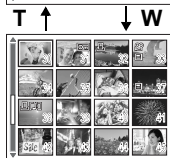
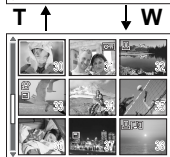

Index display

- You can play back audio and movie files. Use the arrow pad to select the frame you want, and press .
- Push or pull the zoom lever to display the pictures in 4, 9, 16 or 25 frames.
- Press to move to the scroll bar. Press in the scroll bar to display indexes that are outside the monitor.

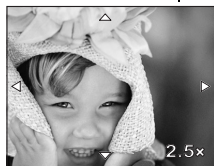

Close-up playback

- Pull the zoom lever toward T to incrementally enlarge the picture up to 5 times the original size.
- Press the arrow pad during close-up playback to scroll the picture in the indicated direction.
- Pictures cannot be stored in an enlarged state.

Scroll bar

Displaying pictures in a calendar (Calendar display)

This function allows you to display the pictures you have taken in a calendar format. When a still picture or movie is recorded, it is automatically registered to the calendar by the date of recording.

You need to have the date and time set on the camera before shooting if you want your pictures to be displayed on the correct date with the calendar display.

☞ “Setting the date and time” (P. 101)



1 In single-frame playback, press Δ .

- The calendar display mode is enabled and the monthly display is displayed.

2 Push or pull the zoom lever to change the calendar display.

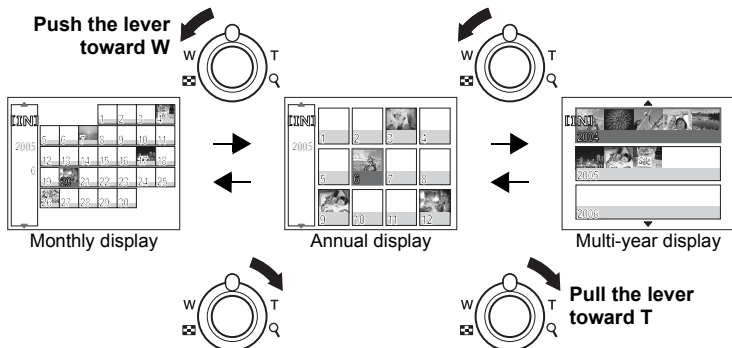

- Use the arrow pad to select the day, month or year.
- Press \odot to display a single frame.

● To exit calendar display mode

1 Press the MENU button.

- The top menu of the calendar display mode is displayed.

2 Press Δ to select [CLOSE CALENDAR].

- The camera returns to normal playback mode.

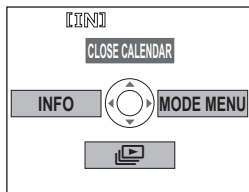

Picture rotation



Pictures taken with the camera held vertically are displayed horizontally. This function lets you turn such pictures 90° clockwise or counterclockwise so that they are displayed vertically.

Select the picture that you want to rotate and display the top menu.



Top menu ▶ [MODE MENU] ▶ [] ▶ [+90°] / [0°] / [-90°]

☞ "Using the menus" (P. 18)

- The picture is rotated 90° clockwise or counterclockwise.

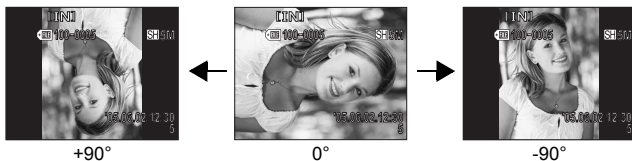

! Note

- The following pictures cannot be rotated.
Movies, protected pictures, pictures registered in an album, pictures that have been edited on a computer, and pictures taken with another camera.
- New picture orientations are saved even when the power is turned off.

Playing back movies



This function lets you play back movies. You can fast forward the movie or play it back one frame at a time.



1 Select the movie you want to play back and press **OK**.

- The camera returns to the previous playback mode when the playback finishes.

● To exit movie playback

Press the **MENU** button to display the top menu, and press **▽** to select [STOP].

● Operations during movie playback

[] appears on movies that have sound recorded. Press **△▽** to adjust the sound volume during playback.

- △** : Increases the volume.
- ▽** : Reduces the volume.
- ▷** : The playback speed doubles while this button is pressed.
- ◁** : Plays the movie in reverse. The reverse playback speed doubles while this button is pressed.
- OK** : Pauses the movie.

● Operations during pause

You can play back the movie frame by frame.

- △** : Displays the first frame.
- ▽** : Displays the last frame.
- ▷** : Displays the next frame.
- ◁** : Displays the previous frame.
- OK** : Playback begins from the selected frame.

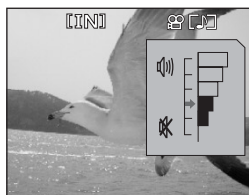
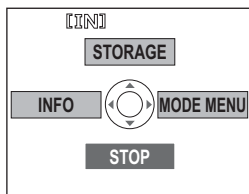

Playing time/
total recording time

! Note

- The self-timer/card access lamp blinks while the camera is reading the movie. Reading of movies may take some time. Do not open the battery compartment/ card cover while the self-timer/card access lamp is blinking. Doing so may damage the data in the internal memory or the card and render the internal memory or card unusable.

Selecting the position to begin movie playback (INDEX PLAY)

This function displays a movie with a time index, allowing you to play back the movie from the desired frame.

5

Additional playback functions



Top menu ▶ [MODE MENU] ▶ [INDEX PLAY] “Using the menus” (P. 18)

1 Press $\Delta \nabla \triangleleft \triangleright$ to select a frame.

- Push or pull the zoom lever to change the number of displayed index frames.

2 Press OK .

- Movie playback begins from the selected frame.

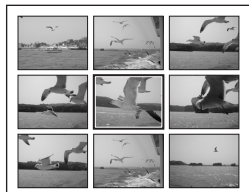

Changing the amount of information displayed on the screen

INFO

This function allows you to change the picture information during playback.

[DETAIL]



[STANDARD]



[NO INFO]



Top menu ▶ [INFO]

☞ “Using the menus” (P. 18)

1 Select [NO INFO], [STANDARD] or [DETAIL], and press **OK**.

- If you select [STANDARD] or [DETAIL], information is displayed for approximately 3 seconds.

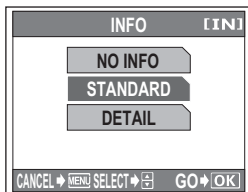

! Note

- No information other than the date and time, frame number and battery check indication is displayed for pictures taken with another camera.

5

Additional playback functions



This function displays still pictures stored in the internal memory or the card one after another. You can select from nine different transition effects. Only the first frame of each movie is displayed. Only sound recorded with still pictures is played back.

STANDARD

The pictures are played back one at a time.

SCROLL

The current picture scrolls off the screen to the left as the next picture scrolls onto the screen from the right.

FADER

The current picture gradually fades out as the next picture gradually fades in.

ZOOM DOWN

The camera gradually zooms out from the current picture until it disappears into the center of the screen. The next picture then appears in the center of the screen, and the camera gradually zooms in on the picture until it is full size.

ZOOM UP

The camera gradually zooms in on the current picture until it disappears. The next picture is displayed with the center enlarged, and the camera then gradually zooms out until the picture is full size.

CHECKERBOARD

The next picture is displayed with a mosaic pattern that gradually disappears to reveal the picture.

BLINDS

The next picture is displayed over the current picture with an effect that resembles a set of blinds opening.

SWIVEL

The current picture is reduced in size and spins off the screen to left as the next picture spins onto the screen from the right and is enlarged to full size. The three-dimensional movement of the two pictures resembles a spinning cube.

RANDOM

The slideshow is displayed with a randomly selected transition effect for each frame ([SCROLL], [FADER], [ZOOM DOWN], [ZOOM UP], [CHECKERBOARD], [BLINDS], or [SWIVEL]).



Top menu ▶ [MENU]

☞ “Using the menus” (P. 18)

- 1 Select a transition effect for the slideshow, and press **OK**.

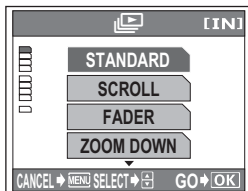

- 2 For calendar display mode, select the types of pictures to be displayed in the slideshow.

ALL All pictures are displayed.

SELECT ALL FROM DATE All pictures for a selected date are displayed.

- [SELECT ALL FROM DATE] can only be selected in calendar display mode or storage playback mode. ☞ “Playing back pictures on the storage unit (STORAGE)” (P. 107)

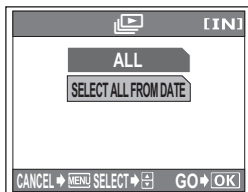

- 3 Press **OK**.

- The slideshow starts.
- During the slideshow, press **◀** to view the previous picture or **▶** to view the next picture.

- 4 Press **OK** or the **MENU** button.

- The slideshow stops and the camera returns to the single-frame playback.

? TIPS

- During index display, the slideshow is displayed in index format. **◀▶** are not available.
- In calendar display mode, the pictures for a date are displayed as individual frames in the slideshow.
- The playing time for each frame during the slideshow is approximately 5 seconds for pictures with recorded sound and approximately 3 seconds for pictures without sound.

! Note

- You are recommended to use the AC adapter when running a slideshow for a long period of time. If the battery is used, the camera will enter sleep mode after about 30 minutes and stop the slideshow automatically.

Adding sound to still pictures



Sound can be added to a still picture that you have already taken. You can also re-record over the sound that has already been recorded. Total recording time per picture is approximately 4 seconds.

Select the still picture to which you want to add sound and display the top menu.



Top menu ▶ [MODE MENU] ▶ [🎤]

👉 “Using the menus” (P. 18)

1 Press **▶** to display [START].

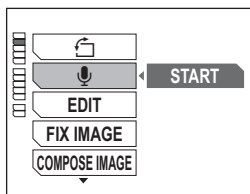

2 Aim the camera microphone toward the sound you want to record, and press **OK** to start recording.

- The [BUSY] bar is displayed during recording.

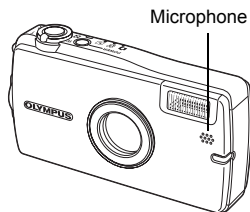

! Note

- If the microphone is farther than 1 m (3.3 ft.) from the subject, sound may not be recorded properly.
- If you re-record the sound, the original sound is erased.
- Sound recording may not be possible if there is insufficient space in the internal memory or the card.
- Sound recording may pick up camera noises, such as button operation or shutter movement.
- Once sound is added to a picture, it is not possible to erase only the sound. In this case, make a re-recording with silence.

Editing still pictures (BLACK & WHITE / SEPIA / /)

This function lets you edit still pictures and save them as new pictures. The following editing operations are possible.

BLACK & WHITE Changes the picture to black and white and saves it as a new file.

SEPIA Changes the picture to sepia and saves it as a new file.
 Changes the image size to 640 × 480 or 320 × 240 and saves the picture as a new file.



 Crops part of a picture and saves it as a new file.

Select the picture that you want to edit and display the top menu.



Top menu ▶ [MODE MENU] ▶ [EDIT]

 “Using the menus” (P. 18)

- 1 Select [BLACK & WHITE], [SEPIA],  or , and press .

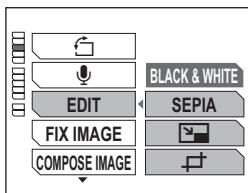

- 2 ● When [BLACK & WHITE] or [SEPIA] is selected

Select [BLACK & WHITE] or [SEPIA], and press .

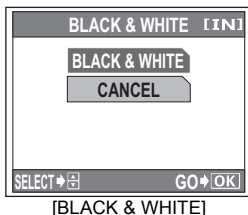

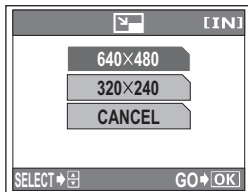

- When  is selected

Select [640 × 480] or [320 × 240], and press .



● When [] is selected

- ① Adjust the trimming position and size.
 Adjusts the position of the picture.
 Zoom lever Adjusts the size of the picture.
- ② Press .
- ③ Select [], and press .



- The [BUSY] bar is displayed and after the image is saved, the camera returns to the playback mode.

! Note

- Editing with [BLACK & WHITE], [SEPIA], [] or [] is not possible in the following cases:
 If there is insufficient space in the internal memory or the card, or for movies, pictures edited with a computer, or pictures taken with another camera.
- If a trimmed picture is printed out, it may appear grainy.

Correcting pictures (REDEYE FIX / BRIGHTNESS / SATURATION)

This function lets you correct still pictures and save them as new pictures. The following corrections are possible.

REDEYE FIX	Corrects the red-eye phenomenon caused by the light from the flash making the subject's eyes appear red in the picture and saves the picture as a new file.
BRIGHTNESS	Corrects the brightness of a picture and saves the picture as a new file.
SATURATION	Corrects the color strength of a picture and saves the picture as a new file.

Select the picture that you want to correct and display the top menu.



Top menu ▶ [MODE MENU] ▶ [FIX IMAGE]  "Using the menus" (P. 18)

- 1** Select [REDEYE FIX], [BRIGHTNESS] or [SATURATION], and press \odot .

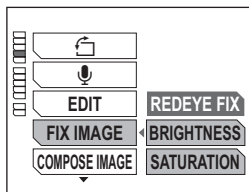

- 2** ● When [REDEYE FIX] is selected

- The picture is displayed with the areas targeted for correction framed in blue.
- The picture is not corrected when there are no parts framed in blue.

- ① Select [REDEYE FIX], and press \odot .

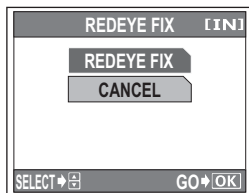
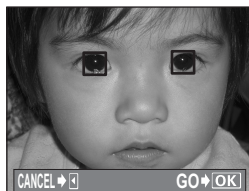

- When [BRIGHTNESS] or [SATURATION] is selected

- ① Press Δ / ∇ to adjust the brightness or saturation.
- ② Press \odot .
- ③ Select [BRIGHTNESS] or [SATURATION], and press \odot .

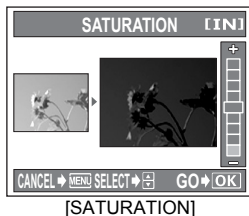

- The [BUSY] bar is displayed and after the image is saved, the camera returns to the playback mode.

Note

- Correcting pictures with [REDEYE FIX], [BRIGHTNESS] or [SATURATION] is not possible in the following cases:

If there is insufficient space in the internal memory or the card, or for movies, pictures edited with a computer, or pictures taken with another camera.

Composing pictures with illustrations

This function lets you add frames, titles or a calendar to still pictures and save them as new pictures. You can also create an index layout of selected pictures and save it as a new picture. The following picture composite operations are possible.

FRAME	Adds a selected frame to a picture and saves it as a new picture.
TITLE	Adds a selected title to a picture and saves it as a new picture.
CALENDAR	Adds a calendar to a picture and saves it as a new picture.
LAYOUT	Creates an index layout of pictures selected in normal playback, album display or calendar display and saves it as a new picture.

Frame



Top menu ▶ [MODE MENU] ▶ [COMPOSE IMAGE] ▶ [FRAME]

"Using the menus" (P. 18)

1 Press to select a frame, and press .

2 Press to select the picture to which you want to add the frame, and press .

- Press to rotate the picture 90° clockwise or counterclockwise.

3 Adjust the position and size of the picture, and press .

Adjusts the position of the picture.

Zoom lever Adjusts the size of the picture.

4 Select [FRAME], and press .

- The [BUSY] bar is displayed and after the image is saved, the camera returns to the playback mode.

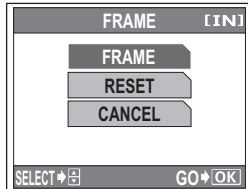
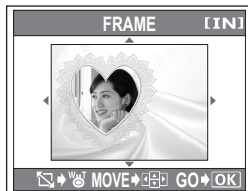
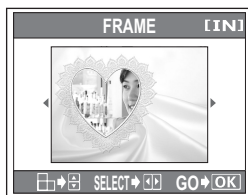

Title



Top menu ▶ [MODE MENU] ▶ [COMPOSE IMAGE] ▶ [TITLE]

☞ “Using the menus” (P. 18)

1 Press ◀▶ to select a picture, and press **OK**.

2 Press ◀▶ to select a title, and press **OK**.

- Press Δ∇ to rotate the title 90° clockwise or counterclockwise.

3 Adjust the position and size of the title, and press **OK**.

Δ∇◀▶ Adjusts the position of the title.

Zoom lever Adjusts the size of the title.

4 Press Δ∇◀▶ to select the color of the title, and press **OK**.

5 Select [TITLE], and press **OK**.

- The [BUSY] bar is displayed and after the image is saved, the camera returns to the playback mode.



Calendar



Top menu ▶ [MODE MENU] ▶ [COMPOSE IMAGE] ▶ [CALENDAR]
 ⓘ “Using the menus” (P. 18)

- 1 Press ◀▶ to select a picture, and press **OK**.
- 2 Press ◀▶ to select a calendar, and press **OK**.
 - Press Δ∇ to rotate the picture 90° clockwise or counterclockwise.
- 3 Set the date of the calendar, and press **OK**.
 - Δ∇ Changes the settings for [Y] and [M].
 - ◀▶ Alternates between the year and month settings.
- 4 Select [CALENDAR], and press **OK**.
 - The [BUSY] bar is displayed and after the image is saved, the camera returns to the playback mode.

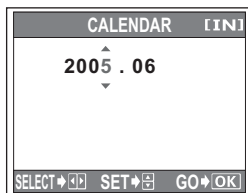
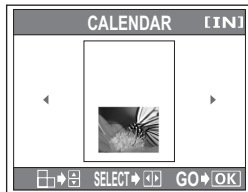

Layout



Top menu ▶ [MODE MENU] ▶ [COMPOSE IMAGE] ▶ [LAYOUT]

☞ “Using the menus” (P. 18)

1 Press ◀▶ to select a layout, and press **OK**.

2 To determine the pictures to be added to the layout, select [ALL IMAGES], [ALBUM], [CALENDAR] or [SEL. IMAGE], and press **OK**.

ALL IMAGES All pictures in the internal memory or the card are added to the layout.

☞ Go to Step 4.

ALBUM All pictures in the selected album are added to the layout.

CALENDAR Select the pictures you want to add to the layout by day, month, or year from the monthly, annual, or multi-year display in calendar display mode.

SEL. IMAGE You select the individual frames to be added to the layout.

3 ● When [ALBUM] is selected

- Press ◀▶ to select an album, and press **OK**.

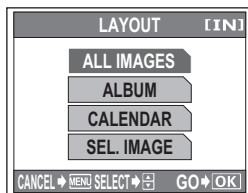

● When [CALENDAR] is selected

- Push or pull the zoom lever to select a year, month or day in the monthly, annual or multi-year display, and press **OK**.

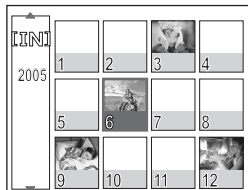

● When [SEL. IMAGE] is selected

- Press \triangleleft or \triangleright to select a picture, and press OK . Repeat this step and select additional pictures until the screen in Step 4 is displayed.
- Press \triangleup or \triangledown to rotate the picture 90° clockwise or counterclockwise.

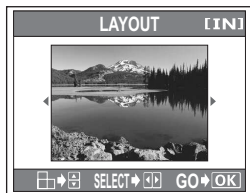
**4 Select [LAYOUT], and press OK .**

- The [BUSY] bar is displayed and after the image is saved, the camera returns to the playback mode.

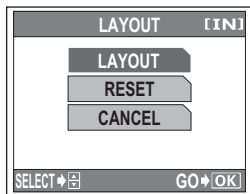
**! Note**

- Creating a composite picture with [FRAME], [TITLE], [CALENDAR] or [LAYOUT] is not possible in the following cases:
If there is insufficient space in the internal memory or the card, or for movies, pictures edited with a computer, or pictures taken with another camera.

? TIPS

- You can add frames and titles using OLYMPUS Master software. As the additions are saved in the internal memory, the number of pictures that can be saved in the memory decreases.

Editing movies

- EDIT** This function lets you extract parts of the movie that you want.
👉 “Editing a movie” (P. 73)
- INDEX** 9 frames extracted from a movie are displayed as an index and stored as a still picture.
👉 “Creating an index” (P. 74)

Select a movie that you want to edit and display the top menu.

Editing a movie



Top menu ▶ [MODE MENU] ▶ [EDIT]

👉 “Using the menus” (P. 18)

1 Select the first frame of the part you want to keep, and press **OK**.

△ : Jumps to the first frame of the movie.

▽ : Jumps to the last frame of the movie.

▷ : Displays the next frame. The movie can be played continuously while this button is pressed.

◁ : Displays the previous frame. The movie can be played continuously in reverse while this button is pressed.

2 As in Step 1, select the last frame of the part you want to keep, and press **OK**.



5

Additional playback functions



3 Select [NEW FILE] or [OVERWRITE], and press .

NEW FILE Stores the edited movie as a new movie.

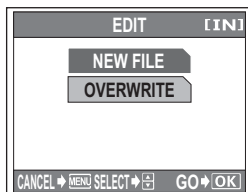
OVERWRITE Stores the edited movie with the same name as the original. The original movie is not stored.



4 Select [YES], and press .

- The [BUSY] bar is displayed and after the edited movie is stored as a new movie or the original movie is overwritten, the camera returns to the playback mode.
- To select different frames, select [RESET] and press . Repeat the procedure from Step 1.
- To quit the editing function, select [CANCEL] and press .

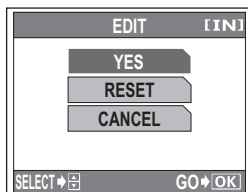

Note

- You cannot select [NEW FILE] if there is insufficient memory space in the internal memory or the card.
- The editing process of long movies is more time-consuming.

Creating an index



Top menu ▶ [MODE MENU] ▶ [INDEX]

 "Using the menus" (P. 18)

1 Select the first frame of the index, and press **OK**.

- △ : Jumps to the first frame of the movie.
- ▽ : Jumps to the last frame of the movie.
- ▷ : Displays the next frame. The movie can be played continuously while this button is pressed.
- ◁ : Displays the previous frame. The movie can be played continuously in reverse while this button is pressed.



2 As in Step 1, select the last frame of the index, and press **OK**.

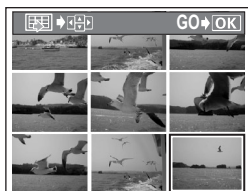

3 Select **[YES]**, and press **OK**.

- The [BUSY] bar is displayed, and the camera returns to playback mode. The index is stored as a new picture.
- To select different frames, select [RESET] and press **OK**. Repeat the procedure from Step 1.
- To quit the editing function, select [CANCEL] and press **OK**.

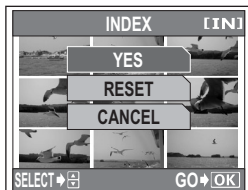

! Note

- The interval between the frames that are automatically extracted varies depending on the length of the movie.
- An index consists of 9 frames.
- You cannot create an index if there is insufficient memory space in the internal memory or the card.

Playing back pictures on a TV

Set the camera in the cradle and connect the supplied AV cable to your TV to play back pictures. You can play back both still pictures and movies on your TV.



1 Make sure that the TV and camera are turned off. Connect the A/V OUT jack on the cradle to the video input terminal on the TV using the AV cable provided with the camera.

2 Set the camera in the cradle.

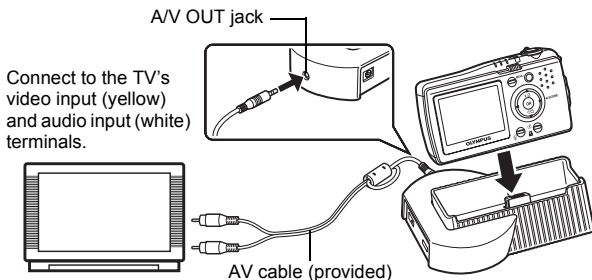

3 Turn the TV on and set it to the video input mode.

- For details of switching to video input, refer to your TV's instruction manual.

4 Press the POWER switch to turn the camera on.

- The last picture taken is displayed on the TV. Use the arrow pad to select the picture you want to display.

? TIPS

- The close-up playback, index display and slideshow functions can also be used on a TV screen.
- You can use the optional remote control (RM-100) to play back pictures on the camera's monitor or TV. This lets you operate functions such as select, erase, and protect, in the same way as you would with the camera's buttons. When the camera is set in the cradle with the power being drawn from the AC adapter, you can use the remote control to turn the camera on/off.

! Note

- Make sure that the camera's video output signal is the same as the TV's video signal. "Selecting the video output" (P. 77)
- The camera's monitor turns off automatically when the AV cable is connected to the camera.
- Be sure to use the AV cable provided to connect the camera to the TV.
- The picture may appear off-center on the TV screen.

Selecting the video output

You can select [NTSC] or [PAL] according to your TV's video signal type. Use this setting when playing back pictures on a TV in a foreign country. Select the [VIDEO OUT] signal before connecting the AV cable. If you select the wrong video signal type, you will not be able to play back the recorded pictures properly on the TV.



Top menu ▶ [MODE MENU] ▶ [SETUP] ▶ [VIDEO OUT] ▶ [NTSC] / [PAL]
 "Using the menus" (P. 18)

? TIPS

- **TV video signal types & main regions**

Check the video signal type before connecting the camera to the TV.

NTSC North America, Taiwan, Korea, Japan

PAL Europe, China

- The factory default setting varies depending on the region where you purchased the camera.

Protecting pictures



You are recommended to protect important pictures to avoid accidentally erasing them. Protected pictures cannot be erased by the single-frame/all-frame erase function, but they are all erased by formatting.

Select the picture you want to protect and display the top menu.



Top menu ▶ [MODE MENU] ▶ [O-π] ▶ [ON] / [OFF]
 "Using the menus" (P. 18)

- To cancel protection, select the protected picture and select [OFF].

Copying pictures in the internal memory to the card (BACKUP)

All image data recorded to the internal memory can be copied (backed up) to a card. Backing up the pictures does not erase them from the internal memory.

You need an optional card to use the backup function. Insert the card into the camera before using this function.



Top menu ▶ [MODE MENU] ▶ [SETUP] ▶ [BACKUP]

"Using the menus" (P. 18)

1 Select [YES], and press .

- All image data in the internal memory is copied to the card.

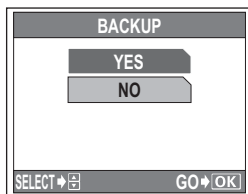

Note

- The backup operation cannot be performed if there are pictures already on the card. Format the card or use a new card.
- If the battery power runs out while the camera is backing up the data, the image data may be lost or damaged. It is recommended that you use the AC adapter when backing up the data.
- Never open the battery compartment/card cover or remove the battery while the camera is backing up data. Also, do not connect or disconnect the AC adapter or remove the camera from the cradle. The internal memory or the card may not operate properly.



This function erases recorded pictures. Pictures can be erased either one at a time or all the pictures in the internal memory or on the card.

Note

- You cannot erase protected pictures. Cancel protection before erasing such pictures.
- Once erased, pictures cannot be restored. Check each picture before erasing to avoid accidentally erasing pictures you want to keep.  “Protecting pictures” (P. 77)



Top menu ▶ [MODE MENU] ▶ [ERASE] ▶ [ERASE] / [ALL ERASE]
 “Using the menus” (P. 18)

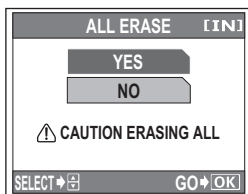

1 Select [YES], and press .

- When [ERASE] is selected, the selected picture is erased. When [ALL ERASE] is selected, all the pictures are erased.



[ALL ERASE]

TIPS

- You can also use the  button to erase pictures.  “Direct buttons” (P. 12)
- In calendar display mode, [ALL ERASE] erases all the pictures associated with the selected day, month, or year.

Note

- Pictures saved in an album cannot be erased with [ALL ERASE]. They need to be erased with [ERASE].

Formatting the internal memory or a card



This function lets you format the internal memory or the memory card. Formatting prepares the internal memory or the card to receive data.

- Make sure there is no card inserted in the camera when formatting the internal memory.
- Be sure that the card is inserted in the camera when formatting the card.
- Before using non-OLYMPUS cards or cards which have been formatted on a computer, you must format them with this camera.

All existing data, including protected pictures, are erased when the internal memory or the card is formatted. Make sure that you save or transfer important data to a computer before formatting the internal memory or the card.



Top menu ▶ [MODE MENU] ▶ [MEMORY FORMAT (FORMAT)]

“Using the menus” (P. 18)

1 Select [YES], and press .

- The [BUSY] bar is displayed while the internal memory or the card is formatted.

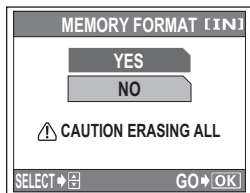

Note

- Do not do any of the following during formatting as such actions may damage the card.
 - Open the battery compartment/card cover
 - Connect or disconnect the AC adapter (regardless of whether there is a battery in the camera or not)
 - Remove the camera from the cradle

Creating and sharing albums

6

Being able to view the pictures taken with your digital camera without having to print them out is a very useful function of your camera. Not only can you check the pictures taken with the camera, you can also share your pictures with others while you are traveling or show your family pictures of your friends.

But with all the pictures in your camera, have you ever felt frustrated not being able to quickly find the pictures you want? By organizing your pictures into different albums by topic, for example, you can quickly and smoothly view the desired pictures. You can also create a slideshow of an album of your favorite pictures.



Adding pictures to an album (ALBUM ENTRY)

You can organize and arrange still pictures, movies and sound recorded with [VOICE REC]. You can save up to 100 still pictures, movies and sounds to each of the available 12 albums.

Select the picture that you want to save to an album and display the top menu.



Top menu ▶ [MODE MENU] ▶ [ALBUM ENTRY]

☞ “Using the menus” (P. 18)

6

Creating and sharing albums

1 Press ◀▶ to select an album, and press **OK**.

- The first picture in the album is displayed.
- No picture is displayed if there are no pictures in the album.



2 Select [THIS IMAGE] or [SEL. IMAGE], and press **OK**.

THIS IMAGE Saves the currently displayed picture to the album.

☞ Go to Step 5.

SEL. IMAGE Selects multiple pictures to save to the album.



3 Press ◀▶ to select the pictures to save to the album, and press **OK**.

- [SET] is checked () . Press **OK** again to uncheck () and cancel saving the picture.
- You can also push the zoom lever toward W to select pictures from the index.

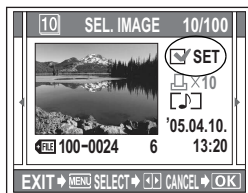

4 After selecting all pictures to save to the album, press the **MENU** button.

5 Select [YES], and press .

- The pictures are saved to the album and the camera returns to the playback mode.

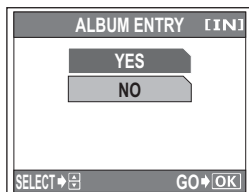

Note

- The number of pictures that can be saved to an album varies depending on the internal memory or card capacity.

Viewing pictures in albums (SEL. ALBUM)

You can play back pictures saved in an album.



Top menu ▶ [SEL. ALBUM]

☞ “Using the menus” (P. 18)

1 Press .

☞ “Direct buttons” (P. 12)

- The album display mode is enabled.

2 Press to select the album that you want to view, and press



- The first picture in the selected album is displayed.



3 Press to select a picture.

- Pull the zoom lever toward T to enlarge the picture. Press the arrow pad while the enlarged picture is displayed to scroll the picture in the desired direction.
- Index display is not available.
- Press to play back a movie or sound.



This is displayed when a picture from the album is played back.

● Operations during still picture playback

- During playback of still pictures with sound, press to adjust the volume.

● Operations during movie playback

- ☞ “Playing back movies” (P. 59)

● Operations during sound playback

- ☞ “Playing back sound recorded with VOICE REC” (P. 91)

4 To exit album display, press the MENU button to display the top menu, and select [CLOSE ALBUM].

? TIPS

- To view pictures from other albums, press the MENU button to display the top menu, and select [SEL. ALBUM].

Rearranging album pictures (REARRANGE)

The pictures in each album are assigned frame numbers in the order the pictures are saved in the album. You can rearrange the pictures and change their frame numbers. When you select an album, the picture with the frame number 1 is displayed.

In album display mode, select the album with the pictures you want to rearrange and display the top menu.



Top menu ▶ [MODE MENU] ▶ [REARRANGE]

☞ “Using the menus” (P. 18)

- 1 Press ◀▶ to select the picture you want to rearrange, and press OK.

The current picture is indicated in red.

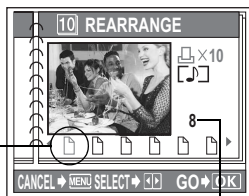

Frame number

- 2 Press ◀▶ to select the new location for the picture, and press OK.

- The album pictures are rearranged.

This indicates the new location of the picture.

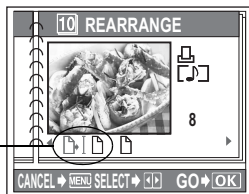

Removing pictures from albums

You can remove pictures saved in an album.

Undoing album entries (UNDO ENTRY / UNDO ALL)

You can undo pictures saved in an album from the album entry.

Undoing a picture from the album entry does not erase the picture. You can still view the picture in normal playback mode.

● Selecting images to undo

In album display mode, select the pictures that you want to undo from the album entry and display the top menu.



Top menu ▶ [MODE MENU] ▶ [UNDO ENTRY]

"Using the menus" (P. 18)

6

Creating and sharing albums

1 Select [THIS IMAGE] or [SEL. IMAGE], and press .

THIS IMAGE Undoes the currently displayed picture.
Go to Step 4.

SEL. IMAGE Selects multiple pictures to undo.



2 Press to select the pictures to undo, and press .

- When a picture is selected, [CANCEL] is checked. Press again to uncheck [CANCEL].



3 After selecting all pictures to undo, press the MENU button.

4 Select [YES], and press .

● Undoing all pictures

In album display mode, display an album with pictures that you want to undo from the album entry and display the top mode.



Top menu ▶ [MODE MENU] ▶ [UNDO ALL] ▶ [YES]

"Using the menus" (P. 18)

? TIPS

- When [UNDO ALL] is performed, protected pictures are also undone from the album entry. However, these pictures are not erased from the internal memory or the card.

Erasing pictures from albums

You can select and erase pictures from an album. When a picture is erased, it is also erased from the internal memory or the card.

! Note

- When [ERASE] is performed, the picture is erased and cannot be restored. To only undo pictures from the album entry, use [UNDO ENTRY] or [UNDO ALL].

In album display mode, display the picture that you want to erase and display the top menu.



Top menu ▶ [MODE MENU] ▶ [ERASE] ▶ [ERASE]

"Using the menus" (P. 18)

1 Select [YES], and press .

- You can also use the button to erase pictures. "Direct buttons" (P. 12)

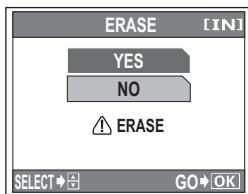

7

Using voice recording

Did you know that you can record sound with your digital camera?

You can record sound when taking a still picture or recording a movie, and the sound is then saved with the still picture or movie.

You can also use the voice recording function to record just sound.

Sound files are displayed in index display or calendar display in the same manner as still pictures and movies, thereby allowing you to easily manage and play back these files.

You can use this function to record important voice memos or audio messages from friends to play back at a later date.

How will you make use of this function?

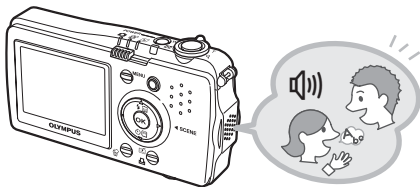
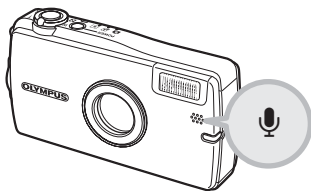

Recording sound (VOICE REC)

You can use this digital camera to record not only still pictures and movies, but also sound. Recorded sound is saved as a WAV file, which is displayed in single-frame or index format in the same manner as still pictures and movies.



Top menu ▶ [VOICE REC]

☞ “Using the menus” (P. 18)

1 Aim the camera microphone toward the sound that you want to record.

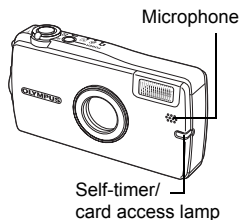

2 Press the shutter button fully.

- The self-timer/card access lamp blinks and sound recording starts.
- The bar displayed during sound recording indicates the following:
 - Bar length : The internal memory or card capacity
 - White part : Used memory space
 - Yellow part : Memory space currently in use
 - Gray part : Remaining memory space

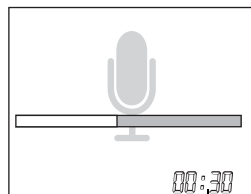

Remaining recording time

3 Press the shutter button again.

- Sound recording stops.

4 To take a picture, press the MENU button, display the voice recording top menu, and select [VOICE REC. END].

7

Using voice recording

Note

- If the microphone is farther than 1 m (3.3 ft.) from the subject, sound may not be recorded properly.
- You cannot take pictures until you exit [VOICE REC] by selecting [VOICE REC. END].
- Sound recording may also pick up camera noises, such as button operations, shutter movement, etc.
- Sound recording may not be possible if there is insufficient space in the internal memory or the card.

Selecting the sound recording quality

You can select from three sound quality settings.

- 1 Select [VOICE QUALITY] from the voice recording top menu.
- 2 Select [FINE], [STANDARD] or [EXTENDED], and press **OK**.

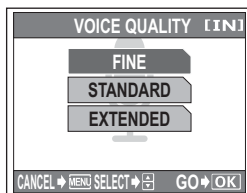
**Turning the monitor on/off**

Select whether to have the monitor remain on or turn off after a certain period of time has elapsed in recording standby.

- 1 Select [MONITOR] from the voice recording top menu.
- 2 Select [ON] or [OFF], and press **OK**.

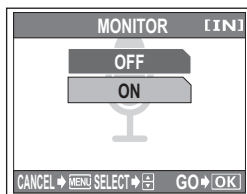

Playing back sound recorded with VOICE REC

You can play back recorded sound.



1 Use the arrow pad to select the sound file that you want to play back, and press **OK**.

- The voice recording sound file is displayed as shown right.
- The sound is played back.
- When sound playback is finished, the camera returns to playback mode.

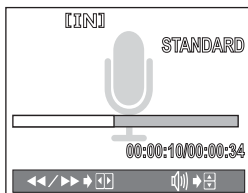

● To exit voice playback

Press the **MENU** button to display the top menu, and press ∇ to select [END PLAYBACK].

● Operations during sound playback

- \triangle : Increases the volume.
- ∇ : Reduces the volume.
- \triangleright : The playback is fast forwarded at double speed while this button is pressed. Sound is not played back.
- \triangleleft : The playback is rewinded at double speed while this button is pressed. Sound is not played back.
- OK** : Pauses playback. Press again to resume normal playback.
- MENU** : Pauses playback and displays the voice playback top menu.

● Operations during pause

- \triangle : Jumps to the start of the sound file.
- ∇ : Jumps to the end of the sound file.
- \triangleright : Advances playback by one second increments.
- \triangleleft : Reverses playback by one second increments.
- OK** : Resumes normal playback.
- MENU** : Displays the voice playback top menu.

Settings

One of the key features of a digital camera is that you can view the pictures you have taken immediately.

But that isn't all.

For example, you can customize the startup screen with your own picture, select your favorite beep, shutter and operation sounds, or set the custom button to quickly access your favorite functions.

Making use of these functions will make such a difference to how much fun you get out of your camera. Why not try them out?

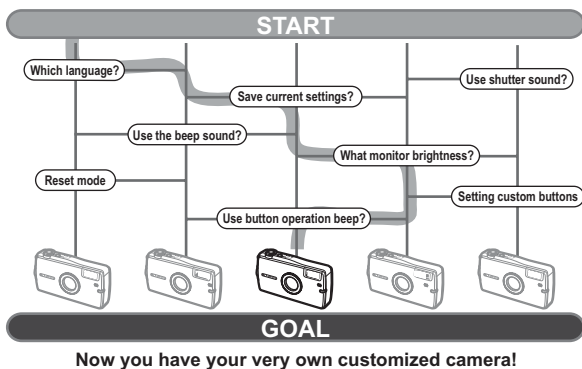

Saving camera settings (ALL RESET)

This function lets you choose whether or not to save the current camera settings after the power is turned off. The settings affected by [ALL RESET] are listed below.

The [ALL RESET] setting applies to all the modes. When [ALL RESET] is set to [OFF] in either shooting mode or playback mode, it applies to both modes.

ON All settings are returned to the factory default settings after the power is turned off.

OFF The settings made before the power is turned off are saved.



Top menu ▶ [MODE MENU] ▶ [SETUP] ▶ [ALL RESET] ▶ [OFF] / [ON]
👉 “Using the menus” (P. 18)

! Note

- The [SETUP] functions ([ALL RESET], [📷], [📹]) etc.) are saved even when [ALL RESET] is set to [ON].

● Functions that return to default settings when [ALL RESET] is set [ON].

Function	Factory default setting	Ref. page	Function	Factory default setting	Ref. page
	0.0	P. 45	(movies)	ON	P. 42
FLASH MODE	AUTO	P. 38		Still picture: [SH] SUPER HIGH 5M Movie: [S] STANDARD	P. 24
METERING	AUTO	P. 47	WB	AUTO	P. 46
	OFF	P. 37	INFO	STANDARD	P. 61
	OFF	P. 43		OFF	P. 49
SCENE SELECT	P-AUTO	P. 32	IMAGE STABILIZER	OFF	P. 41
DIGITAL ZOOM	OFF	P. 36		STANDARD	P. 62
FULLTIME AF	OFF	P. 42	VOICE QUALITY	STANDARD	P. 90
AF MODE	AUTO	P. 48	MONITOR (VOICE REC)	ON	P. 90
(still pictures)	OFF	P. 54			

Selecting a display language



You can select a language for on-screen display. Available languages vary depending on the area where you purchased this camera.

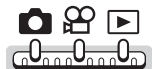

Top menu ▶ [MODE MENU] ▶ [SETUP] ▶ [🗨️]

👉 “Using the menus” (P. 18)

1 Select a language, and press **OK**.

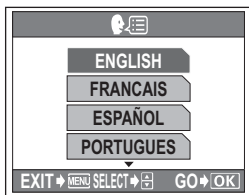

? TIPS

To increase the number of languages

→ You can add other languages to your camera with the provided OLYMPUS Master software. For details, refer to the help in the OLYMPUS Master software.

Changing the startup screen (SCREEN)

You can select the picture that is displayed when the power is turned on.



Top menu ▶ [MODE MENU] ▶ [SETUP] ▶ [SCREEN]

👉 “Using the menus” (P. 18)

1 Select [OFF], [1] or [2], and press

OK.

OFF No picture is displayed (factory default setting).

1 / 2 A picture is displayed.

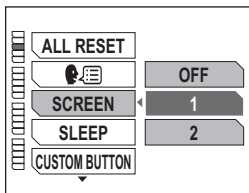

Setting the sleep time (SLEEP)

If no operations are performed for a certain period of time, the camera enters sleep mode (standby) and stops operating. You can set the time until the camera enters sleep mode.



Top menu ▶ [MODE MENU] ▶ [SETUP] ▶ [SLEEP]

"Using the menus" (P. 18)

- 1 Select [30SEC], [1MIN], [3MIN], [5MIN] or [10MIN], and press .

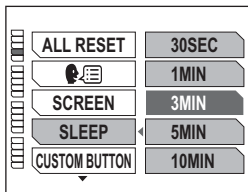

Setting the custom button



Top menu ▶ [MODE MENU] ▶ [SETUP] ▶ [CUSTOM BUTTON]

“Using the menus” (P. 18)

1 Select a function, and press .

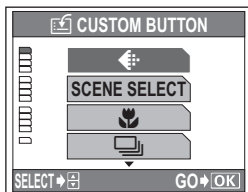

Note

- and cannot be set separately.

Using the custom button



1 Press the button.

“Direct buttons” (P. 12)

- The menu of the set function is displayed.

2 Follow the operation guide to make settings.

Operation guide

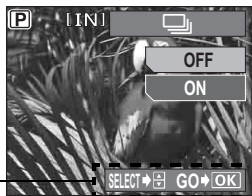

When is set on the [CUSTOM BUTTON]

Setting camera sounds

-)) Select [OFF] or [ON] for the camera warning sound. You can also set the volume of the sound to [LOW] or [HIGH].
- SHUTTER SOUND** Select [OFF], [1] or [2] for the sound of the shutter button. You can also set the volume of the sound to [LOW] or [HIGH].
- BEEP** Select [OFF], [1] or [2] for the sound of the button operations, for example when making menu selections. You can also set the volume of the sound to [LOW] or [HIGH].
- VOLUME** Set the volume for playback of still pictures and movies with sound. There are 5 levels to choose from.



Top menu ▶ [MODE MENU] ▶ [SETUP] “Using the menus” (P. 18)

1 Select [■))], [SHUTTER SOUND], [BEEP] or [VOLUME].

●When [■))] is selected

Select [OFF] or [ON].
If you selected [ON], select [LOW] or [HIGH] and press .

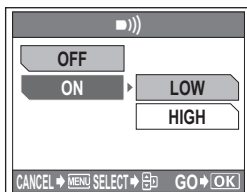

●When [SHUTTER SOUND] or [BEEP] is selected

Select [OFF], [1] or [2].
If you selected [1] or [2], select [LOW] or [HIGH] and press .

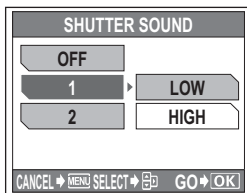

●When [VOLUME] is selected

Press to set the volume, and press .

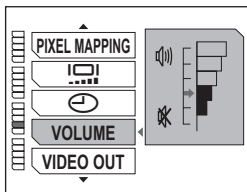

Viewing pictures immediately (REC VIEW)

You can choose whether or not to display the picture you have just taken on the monitor.

- ON** The picture being recorded is displayed. This is useful for making a brief check of the picture you have just taken. Pressing the shutter button halfway during Rec View lets you resume shooting immediately.
- OFF** The picture being recorded is not displayed. This is useful when you want to prepare for your next shot while the previous picture is being recorded.



Top menu ▶ [MODE MENU] ▶ [SETUP] ▶ [REC VIEW] ▶ [OFF] / [ON]
👉 “Using the menus” (P. 18)

Resetting file names (FILE NAME)

The camera automatically creates file names and folder names for pictures to be stored in. Files can be numbered from 0001 to 9999 and folders can be numbered from 100 to 999. Examples are shown below.

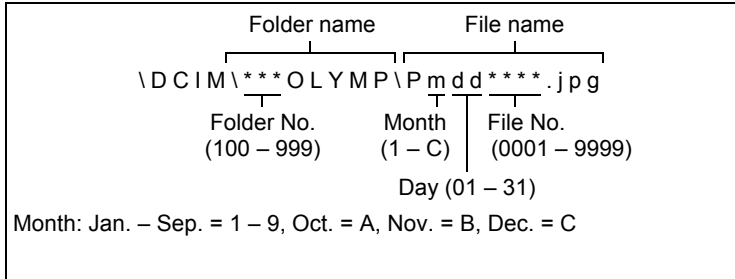

There are two settings from which you can choose: [RESET] or [AUTO]. Choose the one that is best for you when transferring pictures to a computer.

[FILE NAME] settings

RESET The file number and folder number are reset every time a new card is inserted in the camera. The folder number returns to No. 100 and the file number returns to No. 0001. This method is useful when grouping files on separate cards.

AUTO Even if a new card is inserted, the folder number and file number are retained from the previous card, so the same file number is not used on different cards. This helps you to manage multiple cards. This method is useful when you want to manage all your files with sequential numbers.



Top menu ▶ **[MODE MENU]** ▶ **[SETUP]** ▶ **[FILE NAME]** ▶ **[RESET]** / **[AUTO]**
 “Using the menus” (P. 18)

! Note

- When the file number reaches 9999, it returns to 0001, and the folder number changes.
- When both the folder number and file number reach their respective maximum number (999/9999), the number of storable pictures becomes 0 even if the card is not full. No more pictures can be taken. Replace the card with a new one.

Adjusting the monitor brightness

This function lets you adjust the brightness of the monitor to make it easier to see the image.



Top menu ▶ **[MODE MENU]** ▶ **[SETUP]** ▶ **[MONITOR]**
 “Using the menus” (P. 18)

1

Adjust the brightness while looking at the monitor, and when you have set the desired level, press .

- Press to brighten the monitor, and press to darken it.



Setting the date and time



This function lets you set the date and time. The date and time is saved with each image, and is used in the file name.



Top menu ▶ [MODE MENU] ▶ [SETUP] ▶ [🕒]

👉 “Using the menus” (P. 18)

1 Select one of the following date formats: [Y-M-D] (Year/Month/Day), [M-D-Y] (Month/Day/Year), [D-M-Y] (Day/Month/Year), and press **▷**.

- Move to the year setting.
- The following steps show the procedure used when the date and time settings are set to [Y-M-D].

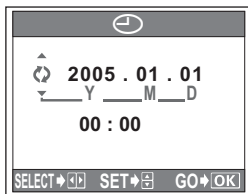

2 Press **△▽** to set the year, and press **▷** to move to the month setting.

- To move back to the previous setting, press **◀**.
- The first two digits of the year are fixed.

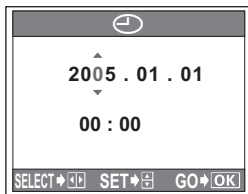

3 Repeat this procedure until the date and time are completely set.

- The time is displayed in the 24-hour format. Consequently, 2 p.m. is displayed as 14:00.

4 Press **⊙**.

- For a more accurate setting, press **⊙** when the time signal hits 00 seconds.

! Note

- The date and time will be returned to the factory default settings if the camera is left without the battery for approximately 1 day. The settings will be canceled more quickly if the battery was only loaded in the camera for a short time before being removed. Before taking important pictures, check that the date and time settings are correct.
- If the date and time setting is canceled, a warning is displayed on the monitor the next time the camera is turned on. 👉 “Error messages” (P. 145)

Resetting the camera settings (MODE RESET)

This function resets the shooting and playback settings to the factory default settings. This function also resets those settings saved when [ALL RESET] is set to [OFF].



Top menu ▶ [MODE MENU] ▶ [SETUP] ▶ [MODE RESET]

“Using the menus” (P. 18)

1 Select [YES], and press .

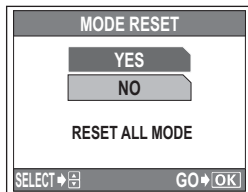

? TIPS

- is not reset.

Adjusting the image processing function (PIXEL MAPPING)

The pixel mapping feature allows the camera to check and adjust the CCD and image processing functions. It is not necessary to operate this function frequently. Approximately once a year is recommended. Wait at least one minute after taking or viewing pictures to allow the pixel mapping function to perform properly.



Top menu ▶ [MODE MENU] ▶ [SETUP] ▶ [PIXEL MAPPING]

"Using the menus" (P. 18)

1 When [START] is displayed, press .

- The [BUSY] bar is displayed during pixel mapping. When pixel mapping is finished, the screen returns to the mode menu.

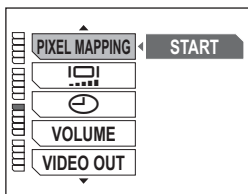

Note

- If you turn the camera off during pixel mapping, start again from Step 1.

Dock&Done functions

This camera features Dock&Done, which allows you to store and print pictures without the use of a computer. As a gift idea, you can copy pictures from the camera to a CD. Or you can adjust, edit, or enhance your pictures, and print them. All these steps you can make just by using the menus on the camera.*

Try Dock&Done to take, view, store, browse, display, decorate, and share your pictures in the way you would with conventional photographs.

* Requires a Dock&Done storage unit (hard disk/DVD) and Dock&Done printer.

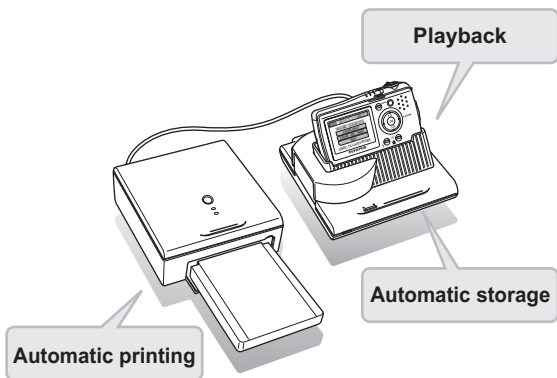

Using the camera with a Dock&Done storage unit (hard disk/DVD)

You can store new pictures to a storage unit (hard disk/DVD). You can also use the camera's monitor to play back pictures stored in the storage unit. The [STORE] setting is set to [STORE] for newly taken pictures. Once a picture is stored, the setting automatically is canceled to prevent storing the same picture multiple times. This setting can be changed for each picture.

 For detailed operations of the Dock&Done storage unit, see the manual provided with the optional Dock&Done hard disk or DVD storage unit.

Storing camera pictures (STORE ONLY)

- 1** Dock the cradle provided with the camera on the storage unit.

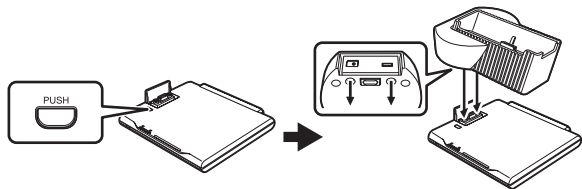

- 2** Connect the AC adapter to the storage unit and the power cable to a wall outlet.

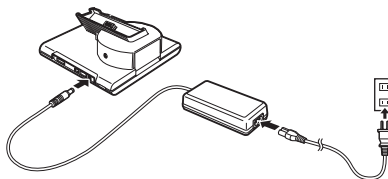

- 3** Set the Dock&Done mode/PC mode switch on the storage unit to **[DOCK]**, and turn on the storage unit.

- Insert a disk into the DVD storage unit before use.

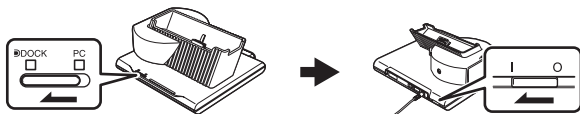

4 Set the camera in the cradle.

- The camera turns on, and the [DOCK MODE] screen is displayed.
- The camera is powered by the AC adapter of the storage unit.
- When an unformatted disk is inserted in the DVD storage unit, the disk format screen is displayed. For details, refer to the instruction manual for your DVD storage unit.

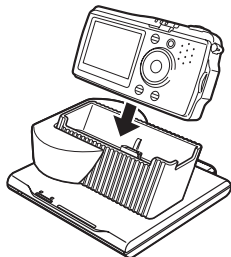

5 Select [STORE ONLY], and press

OK.

- The displayed screen and selectable items vary depending on the camera settings.
 - "Camera settings" (P. 113),
 - "[DOCK MODE] screen menu" (P. 112)
- When the pictures have been stored, the camera turns off automatically.

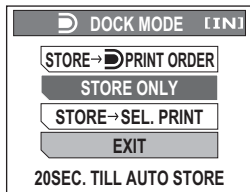

? TIPS

- You can also individually select the pictures to be stored to the storage unit.
 - "Storing pictures (STORE)" (P. 113)
- You can also set the camera to automatically erase pictures after they have been stored to the storage unit.
 - "Settings after storing (STORE AND)" (P. 113)
- When the camera is off, the camera battery is charged by the AC adapter of the storage unit.

! Note

- When a card is inserted in the camera, only the pictures on the card are stored. To store pictures in the internal memory, remove the card.
- Packet-writing software is required if you want to view pictures stored on a disk with the DVD storage unit. For details about packet-writing software, see the manual of the optional Dock&Done DVD storage unit.

Playing back pictures on the storage unit (STORAGE)

You can use the camera's monitor to view pictures stored in the storage unit. Before operating the menus, make sure the camera, cradle and storage unit are set up.

If the [DOCK MODE] screen is displayed, select [EXIT], and press .



Top menu ▶ [STORAGE]



 "Using the menus" (P. 18)

1 The pictures are displayed in multi-year format.

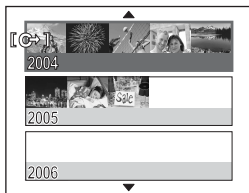
- Push or pull the zoom lever to display the pictures in multi-year, annual, monthly, index, or single-frame format.



2 Pull the zoom lever toward T to display the pictures in single-frame format.

- Press   to move through the pictures.
- If a movie or VOICE REC sound is indicated, press  to play it back.









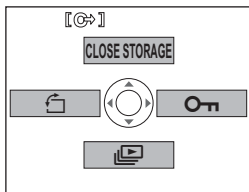



 is displayed during storage playback

3 To exit storage playback, press the MENU button to display the top menu of the storage playback mode, and select [CLOSE STORAGE].

- Storage playback stops and the pictures on the camera are played back.



? TIPS

- The following operations can be performed in storage playback mode:
 -   "Picture rotation" (P. 58)
 -   "Slideshow" (P. 62)
 -   "Protecting pictures" (P. 77)
- Delete all pictures by date  Press the **MENU** button during multi-year, annual or monthly display to display the top menu, and select [ALL ERASE].
-  button  "Direct buttons" (P. 12)
-  button  "Using the camera with a Dock&Done printer" (P. 110)

! Note

- The steps to play back movies and sound with the storage playback function may differ from those for normal playback.
- The Hard disk storage unit (S-HD-100) needs to support the playback function. If not, you require a firmware upgrade. For details, visit a homepage listed below.
 - North and South America: http://www.olympusamerica.com/IR500_storage
 - Europe: <http://www.olympus-europa.com/site/ir-500-storage>
 - Other areas: Contact the customer support center.

Creating a disk for storing pictures (CREATE SHARE DISK)

You can use the Dock&Done DVD storage unit to easily burn a CD or DVD of all pictures stored in the camera.

- Have the cradle and DVD storage unit set up. Set the camera after selecting the menu.
- Set an unused (unformatted) DVD or CD in the DVD storage unit.

 For detailed operations of the Dock&Done DVD storage unit, see the manual provided with the optional Dock&Done DVD storage unit.



Top menu ▶ [MODE MENU] ▶ [CREATE SHARE DISK]

 "Using the menus" (P. 18)

1 Select [START], and press .

- A message is displayed on the camera's monitor.

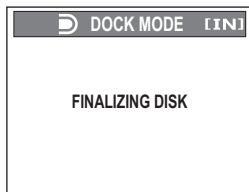
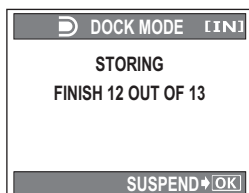
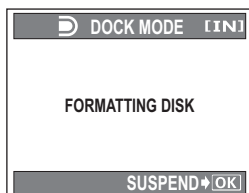
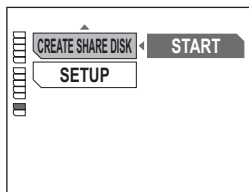

2 Set the camera in the cradle.

- A message is displayed indicating that the disk is being formatted.
- A message is displayed indicating that pictures are being stored to the disk.

- When the pictures have been stored, the DVD tray is ejected from the unit.
- The camera display returns to the mode menu.

TIPS

- To create multiple disks, remove the camera from the cradle and set an unused CD or DVD in the DVD storage unit before repeating Steps 1 and 2.

Note

- Disks recorded with [CREATE SHARE DISK] cannot be used to record additional pictures.

Using the camera with a Dock&Done printer

You can use your digital camera and a Dock&Done storage unit (hard disk/DVD) with a Dock&Done printer to print pictures stored in your camera or the storage unit.

You can print pictures from the [DOCK MODE] screen displayed when connecting the camera to the Dock&Done storage unit or from the print top menu displayed when the camera's  button is pressed.

-  For detailed operations of the Dock&Done storage unit or printer, see the manual provided with the optional Dock&Done storage unit (hard disk/DVD) or Dock&Done printer.

Using a Dock&Done storage unit with a Dock&Done printer

The [DOCK MODE] screen can be used to print pictures after they have been stored in the storage unit. Set [NEW ALL PRINT] to [ON] on the camera in advance.  "Printing all new pictures (NEW ALL PRINT)" (P. 114)

- 1** Connect the AC adapter and power cable of the storage unit, and connect the printer to the storage unit using the Dock&Done cable, then turn the printer on.

2 Dock the cradle on the storage unit.

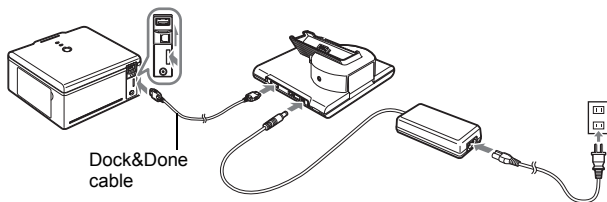

3 Set the Dock&Done mode/PC mode switch on the storage unit to [DOCK], and turn on the storage unit.



4 Set the camera in the cradle.

- The camera is powered by the AC adapter of the storage unit.
- The camera turns on, and the [DOCK MODE] screen is displayed.

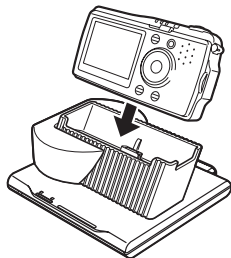

5 Select [STORE→NEW ALL PRINT], and press [OK].

- The displayed screen and selectable items vary depending on the camera settings.
 - ☞ “Camera settings” (P. 113)
- New pictures in the camera are stored in the storage unit and then printed.
- When printing is finished, the camera turns off automatically.

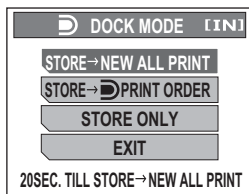

● [DOCK MODE] screen menu

The displayed menu varies depending on the camera settings and whether or not print reservations have been made.

The following menu items are available on the [DOCK MODE] screen menu: Unavailable menu items cannot be selected.

STORE→PRINT ORDER	Stores new pictures to the storage unit, and then prints pictures with print reservations.
STORE ONLY	Stores new pictures to the storage unit.
STORE→SELECT PRINT	Stores new pictures to the storage unit, and then prints selected pictures.
STORE→NEW ALL PRINT	Stores new pictures to the storage unit, and then prints all new pictures.
PRINT ORDER	Prints pictures with print reservations.
SELECT PRINT	Prints selected pictures.
NEW ALL PRINT	Prints all new pictures not yet stored to the storage unit.



Using a Dock&Done printer

Connect the camera and printer and press the  button during playback mode to display the print top menu.

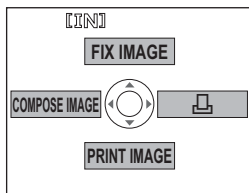
To connect the camera directly to the Dock&Done printer, use the USB cable provided. The features on the print top menu may vary depending on the printer model and the printer connection status.



● Print top menu

FIX IMAGE	Allows you to edit or adjust a picture selected from the camera, and then prints the picture. For details on these functions, see “Correcting pictures (REDEYE FIX / BRIGHTNESS / SATURATION)” (P. 66) “Editing still pictures (BLACK & WHITE / SEPIA /  / )” (P. 65).
COMPOSE IMAGE	Allows you to change the composition of the picture selected from the camera, and prints it or stores it as a new picture. For details on these functions, see “Composing pictures with illustrations” (P. 68).
	Creates print reservations for pictures stored in the internal memory or the card in the camera. “Print settings (DPOF)” (P. 123)
PRINT IMAGE	Allows you to select the pictures in the camera or storage unit to print. Allows you to select pictures in the camera to print when connected only to a printer. “Direct printing (PictBridge)” (P. 116)

● Connecting to a printer

- **Connecting a Dock&Done printer to a Dock&Done storage unit with a Dock&Done cable**

All functions are available. You can also print pictures stored in the storage unit. Select [EXIT] on the [DOCK MODE] screen after storing the pictures in the storage unit. Press the [] button during storage playback, and select [PRINT IMAGE] to print. “Storing camera pictures” (P. 105), “Playing back pictures on the storage unit (STORAGE)” (P. 107)

- **Connecting to a PictBridge-compatible printer**

[FIX IMAGE] and [COMPOSE IMAGE] can be set, but printing is not possible. Set pictures can be stored to the camera. [PRINT IMAGE] can be set and printing is possible. [] can be set.

Camera settings

You can set the camera settings for storing pictures to the storage unit and printing pictures.

Storing pictures (STORE)

This function allows you to individually set which pictures in the camera are to be automatically stored in the storage unit. You can set those pictures that have been automatically stored to [STORE] and store these to a different disk, or set newly taken pictures to [NOT STORE] and store only those pictures that you want to keep.

Select the picture that you want to set and display the top menu.



Top menu ▶ [MODE MENU] ▶ [STORE] ▶ [STORE] / [NOT STORE]

“Using the menus” (P. 18)

Settings after storing (STORE AND)

You can set whether pictures are erased from the camera or kept in the camera after they have been stored to a storage unit.



Top menu ▶ [MODE MENU] ▶ [SETUP] ▶ [STORE AND] ▶
[ERASE] / [KEEP]

“Using the menus” (P. 18)

? TIPS

- The following pictures are not erased even when [STORE AND] is set to [ERASE]:
 - Pictures registered in an album, pictures with print reservations*, and protected pictures.
- * If [PRINT AND] is set to [CANCEL] for pictures with print reservations, the reservations are canceled after the pictures are printed, and the pictures are erased.

Printing all new pictures (NEW ALL PRINT)

You can set whether to automatically print camera pictures not stored in a storage unit.



Top menu ▶ [MODE MENU] ▶ [SETUP] ▶ [NEW ALL PRINT] ▶ [ON] / [OFF]
 "Using the menus" (P. 18)

Settings after printing (PRINT AND)

You can set whether to keep or cancel print reservations after selecting [PRINT ORDER] on the [DOCK MODE] screen and printing pictures. This prevents you from repeatedly printing the same picture by mistake. Setting this to [CANCEL] cancels all print reservations in the camera after printing them.



Top menu ▶ [MODE MENU] ▶ [SETUP] ▶ [PRINT AND] ▶
 [CANCEL] / [KEEP] "Using the menus" (P. 18)

Printing pictures

10

You can print out the pictures you have taken either at a photo store or at home on your own printer.

If you go to a photo store, it is a good idea to store the print reservation data on the card first. This lets you select the pictures you want to print and decide how many prints you want.

If you print the pictures at home, you can either connect the camera directly to the printer or you can connect the camera to a computer and download the pictures to the computer first.

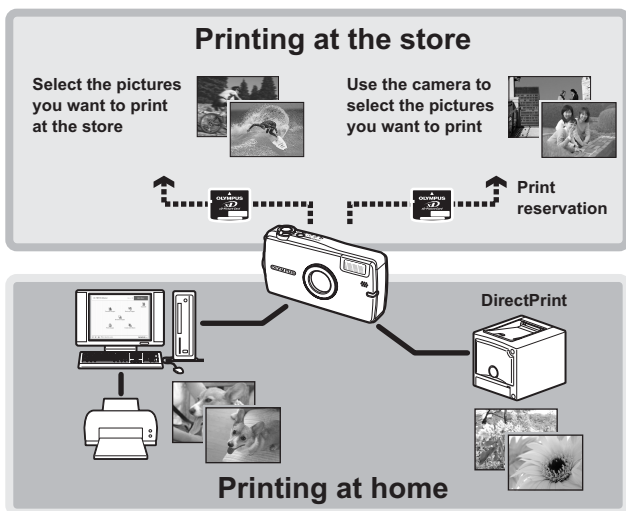

Direct printing (PictBridge)

Using the direct printing function

By connecting the camera to a PictBridge-compatible printer with the USB cable, you can print out recorded pictures directly. With the camera connected to the printer, select the pictures you want to print and the number of prints on the camera's monitor. It is also possible to print out pictures using the print reservation data.

 "Print settings (DPOF)" (P. 123)

To find out if your printer is compatible with PictBridge, refer to the printer's instruction manual.

What is PictBridge?... It is the standard for connecting digital cameras and printers of different manufacturers and printing out pictures directly.

STANDARD... All printers that support PictBridge have standard print settings. If [STANDARD] is selected on the settings screens (P. 117 to 121), pictures are printed according to these settings. Refer to the printer's instruction manual for its standard settings or contact the printer manufacturer.

TIPS

- For details of printing paper types, ink cassettes, etc., refer to the printer's instruction manual.

Note

- You are recommended to use the AC adapter when printing pictures. If you use the battery, make sure that it is sufficiently charged. If the camera stops operating while communicating with the printer, the printer may malfunction or image data may be lost.
- Movies cannot be printed.
- The camera will not enter sleep mode when connected to a printer with the USB cable.

Print modes and settings

Available printing modes, paper sizes etc., vary depending on the printer you use. Refer to the instruction manual for your printer.

Printing pictures

Use the USB cable provided to connect the camera to a PictBridge-compatible printer.

Try printing one picture with the most basic printing method. The selected picture is printed using the standard settings of your printer. The date and file name are not printed.

1 Turn the printer on and plug the printer end of the USB cable into the printer's USB port.

- For details of how to turn the printer on and the position of the USB port, refer to the printer's instruction manual.

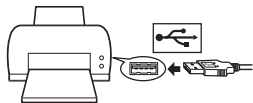

2 Plug the other end of the USB cable into the USB terminal on the cradle.

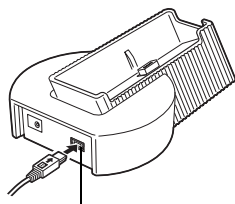



USB connector

3 Set the camera in the cradle.

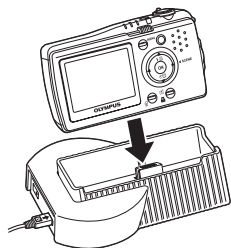
- The camera automatically turns on.
- The monitor turns on and the selection screen for the USB connection is displayed.



4 Select [SEL. PRINT] and press

-  [SEL. PRINT] can only be used with a Dock&Done printer.
-  "Using the camera with a Dock&Done printer" (P. 110)

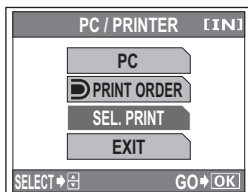

- “ONE MOMENT” is displayed and the camera and printer are connected. The [PRINT MODE SELECT] screen is displayed on the monitor. Select the print settings on the camera’s monitor.

5 Select [ALL IMAGES], and press

OK.

- Select [ALBUM] to select and print pictures from an album.

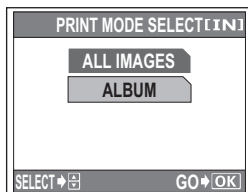

6 Select [PRINT], and press **OK**.

- The [PRINTPAPER] screen is displayed.

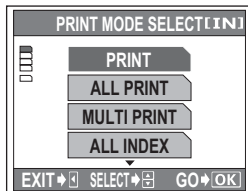

7 Press **OK** without changing the [SIZE] or [BORDERLESS] settings.

- When the [PRINTPAPER] screen is not displayed, go to Step 8.

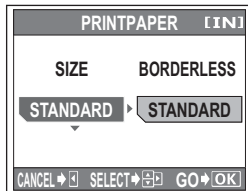

8 Press **Left/Right** to select a picture, and press **OK**.

- The [PRINT] screen is displayed.



9 Select [PRINT], and press **OK**.

- Printing starts.
- When printing is finished, the [PRINT MODE SELECT] screen is displayed.

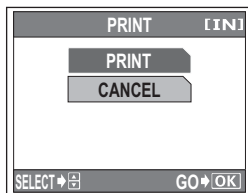

● To cancel printing

Pressing **OK** during print data transfer displays the screen for selecting whether to continue or cancel printing. To cancel printing, select [CANCEL] and press **OK**.

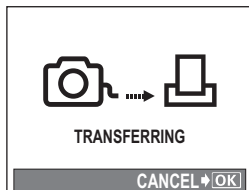

Screen during data transfer

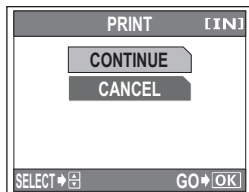

10 In the [PRINT MODE SELECT] screen, press **◀**.

- A message is displayed.

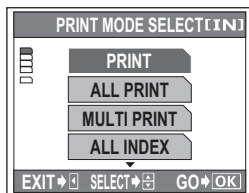

11 Remove the USB cable from the cradle.

- The camera turns off.

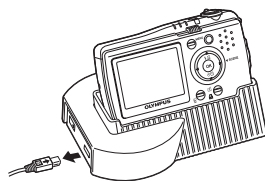

12 Remove the USB cable from the printer.

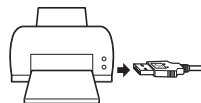

Other print modes and print settings

In addition to the basic printing method, there are also several other printing modes. The paper size and borderless settings can be set in the same print mode. If the following screen is displayed, perform the operations according to the operation guide.

Selecting the picture to print

- ALL IMAGES** Allows you to select from all pictures in the internal memory or the card to print.
- ALBUM** Select an album and the pictures in the album to print.

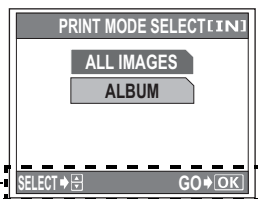

Selecting a print mode

- PRINT** Prints the selected picture.
- ALL PRINT** Prints all the pictures stored in the internal memory or the card.
- MULTI PRINT** Prints one picture in multiple layout format.
- ALL INDEX** Prints an index of all the pictures stored in the internal memory or the card.
- PRINT ORDER** Prints the pictures according to the print reservation data on the card. If no print reservations have been made, this option is not available.
- ☞ "Print settings (DPOF)" (P. 123)

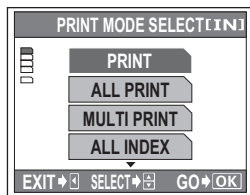

Setting the print paper

Select the paper size and border on the [PRINTPAPER] screen.

- SIZE** Choose from the available paper sizes on your printer.
- BORDERLESS** Select framed or unframed. In [MULTI PRINT] mode, you cannot select the frame.
- OFF** The picture is printed inside a blank frame.
- ON** The picture is printed filling the entire page.
- PICS/SHEET** Available in [MULTI PRINT] mode only. The number of prints that can be printed vary depending on the printer.

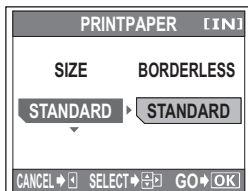

! Note

- If the [PRINTPAPER] screen is not displayed, [SIZE], [BORDERLESS] and [PICS/SHEET] are set to [STANDARD].

Selecting the picture to print

Press \triangleleft \triangleright to select the picture you want to print. You can also push or pull the zoom lever and select a picture from the index display.

- PRINT** Prints one copy of the selected picture.
- SINGLE PRINT** Makes a print reservation for the displayed picture. Print reservation icon is displayed.
- MORE** Sets the number of prints and data to be printed for the displayed picture.



Setting the number of prints and data to be printed



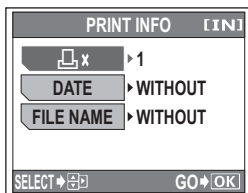





- x** Sets the number of prints. You can select up to 10 prints.
- DATE** \odot If you select [WITH], pictures are printed with the date and time.
- FILE NAME** \odot If you select [WITH], pictures are printed with the file name.



If an error message is displayed

If an error message is displayed on the camera's monitor during direct print setting or printing, see the following table.

For more details, refer to the printer's instruction manual.

Monitor indication	Possible cause	Corrective action
 NO CONNECTION	The camera is not connected to the printer correctly.	Disconnect the camera and connect it again correctly.
 DOCK&DONE PRINTER IS NOT CONNECTED	[ PRINT ORDER] was selected, but the camera was not connected to a Dock&Done printer.	If [ PRINT ORDER] is set on the [PC/PRINTER] screen, connect to a Dock&Done printer.
 NO PAPER	There is no paper in the printer.	Load some paper in the printer.
 NO INK	The printer has run out of ink.	Replace the ink cartridge in the printer.
 JAMMED	The paper is jammed.	Remove the jammed paper.
SETTINGS CHANGED	The printer's paper tray has been removed or the printer has been operated while changing settings on the camera.	Do not operate the printer while changing settings on the camera.
 PRINT ERROR	There is a problem with the printer and/or camera.	Turn off the camera and printer. Check the printer and remedy any problems before turning the power on again.

? TIPS

- If an error message other than those shown above is displayed, see "Error messages" (P. 145).



How to make print reservations

Print reservation allows you to save printing data (the number of prints and the date/time information) with the pictures stored in the internal memory or on the card.

With print reservation, you can print out pictures easily either at home using a personal DPOF-compatible printer or at a photo store that supports DPOF. DPOF is a standard format used to record automatic print information from digital cameras. It allows you to store data such as which pictures you want to print and the number of prints so that you can print pictures automatically at home or at a photo store.

Pictures with print reservations can be printed using the following procedures.

Printing using a DPOF-compatible photo store.

You can print the pictures using the print reservation data.

Printing using a DPOF-compatible printer.

Printing is possible directly from a card containing print reservation data, without using a computer. For more details, refer to the printer's instruction manual. A PC card adapter may also be necessary.

To use print services without using DPOF

Pictures stored in the internal memory cannot be printed at a photo store. The pictures need to be copied to a card before taking them.



 "Copying pictures in the internal memory to the card (BACKUP)" (P. 78)

? TIPS**Relation between printing and record mode when shooting**

The resolution of a computer/printer is generally based on the number of dots (pixels) per inch (dpi). The higher the dpi value, the better the printed results. Keep in mind, however, that the dpi of the picture does not change. This means that when you print an image with a higher resolution, the size of the printed picture will be smaller. Although you can print magnified images, picture quality will decrease.

If you want to print large, high-quality pictures, set the record mode as high as possible when taking the pictures.  "Record mode" (P. 24)

! Note

- DPOF reservations set by another device cannot be changed by this camera. Make changes using the original device.
- If a card contains DPOF reservations set by another device, entering reservations using this camera may overwrite the previous reservations.
- If there is not enough space in the internal memory or card memory, you may not be able to enter the reservation data. [CARD FULL] will be displayed.
- You can make DPOF print reservations for up to 999 images per card.
- Even if an image is displayed with the message [PICTURE ERROR], it may be possible to make print reservations. In this case, the print reservation icon () is not displayed when the image is displayed for full view.  is displayed when there are multiple images (index display), allowing you to confirm the print reservation.
- Not all functions may be available on all printers, or at all photo stores.
- Print reservation may take a little time when saving printing data.

Single-frame reservation

10

Printing pictures

How to apply  to a selected picture is shown below. Follow the operation guide to make settings.

**1 Press the  button.**

- The print top menu is displayed.

2 Select [P].

- If data is already stored on the card, the screen appears, giving you the choice of resetting the data or keeping it.
- For details on [FIX IMAGE] and [COMPOSE IMAGE], see "Using a Dock&Done printer" (P. 112).
- For details on [PRINT IMAGE], see "Direct printing (PictBridge)" (P. 116).

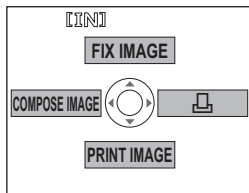

3 Select [P], and press [OK].

- If you want to make print reservations for an album, select [ALBUM], and select [P] or [A].

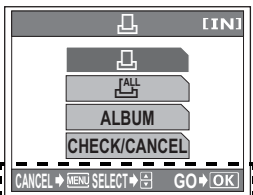

Operation guide

4 Follow the operation guide and press [Left] [Right] to select the frames for print reservations, and then press [Up] [Down] to set the number of prints.

- You cannot make print reservations for pictures with [P].
- Repeat Step 4 to make print reservations for other pictures.

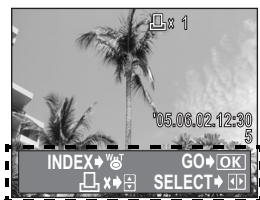

Operation guide

5 When you are finished making print reservations, press [OK].

6 Select [NO], [DATE] or [TIME], and press [OK].

- NO** The pictures are printed without the date and time.
- DATE** The selected pictures are printed with the shooting date.
- TIME** The selected pictures are printed with the shooting time.

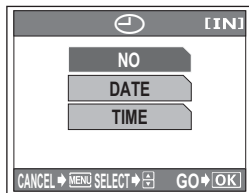

Single-frame reservation screen

- 7** Select [SET], and press .

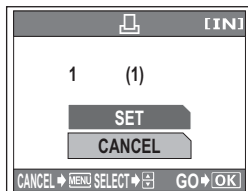





All-frame reservation



Reserves all the pictures stored in the internal memory or on the card. The number of prints is set at one print per picture. You can set to print the shooting date/time.



- 1** Select [] on the [] screen, and press .
- 2** Select [NO], [DATE] or [TIME], and press .
 - NO** The pictures are printed without the date and time.
 - DATE** All pictures are printed with the shooting date.
 - TIME** All pictures are printed with the shooting time.
- 3** Select [SET], and press .

Resetting print reservation data



This function allows you to reset the print reservation data for pictures. You can reset all the print reservation data or just for selected pictures.



- **To reset the print reservation data for all the pictures**

- 1** Press the  button.
 - The print top menu is displayed.

2 Select [PRINT].

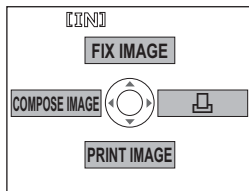

3 Select [RESET], and press [OK].

- If there is no print reservation data, this screen is not displayed.

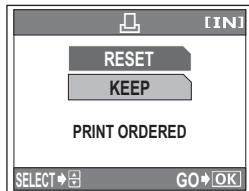

● To reset the print reservation data for a selected picture

1 Select [KEEP] on the [PRINT] screen, and press [OK].

- If there is no print reservation data, this screen is not displayed.

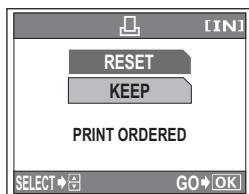

2 Select [CHECK/CANCEL], and press [OK].

3 Press [LEFT] [RIGHT] to display the picture with the reservation data you want to reset, select [CANCEL], and press [OK].

- The print reservation data is reset.
- Select [CANCEL ALL] to reset the print reservation data for all the pictures.

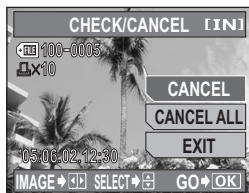

4 If you are finished resetting the print reservation data, select [EXIT], and press [OK].

Connecting the camera to a computer

Viewing the pictures you have taken on your computer is just one of the many ways you can enjoy your pictures.

You can print out your favorite pictures, use the application software to download your pictures from your camera and edit them or organize them by date or category, or attach them to e-mail and send them over the Internet.

There are all kinds of ways you can use your pictures with a computer. You can run a slideshow, post your pictures on your home page, create an album, or set your favorite picture as your desktop wallpaper.

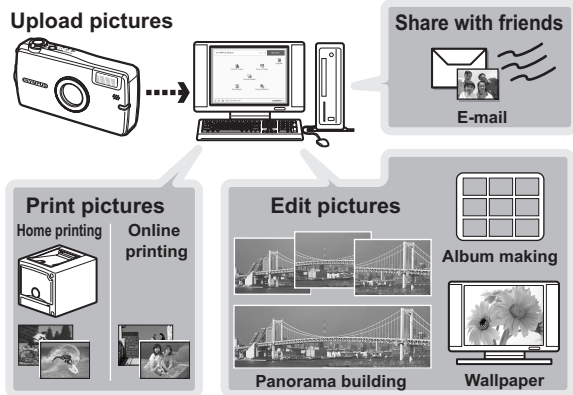

Flow

Using the USB cable provided with your camera, you can connect the camera and computer and download (transfer) the images to your computer using the OLYMPUS Master software, also provided with the camera.

Prepare the following items before starting.



OLYMPUS Master
CD-ROM

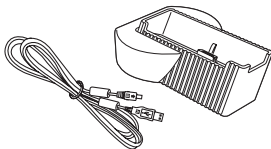

USB Cable

Cradle

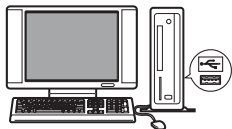

Computer equipped with a
USB port

Install the OLYMPUS Master software

➡ P. 131



Connect the camera to the computer using the USB cable

➡ P. 135



Start up the OLYMPUS Master software

➡ P. 136



Download image files to the computer

➡ P. 138



Disconnect the camera from the computer

➡ P. 139

? TIPS

Viewing and editing downloaded images

→ If you want to process images using graphics applications, make sure you download the images to your computer first. Depending on the software, the image files may be damaged if the images are processed (rotated, etc.) while they are still in the internal memory or on the card.

If the data cannot be downloaded from the camera using the USB cable

→ Image files on xD-Picture Card may be downloaded using the optional PC card adapter. For details, visit the Olympus web site at the address shown on the back cover of this manual.

! Note

- It is recommended that you use the AC adapter when connecting the camera to a computer. If you use a battery, make sure it has enough power. The camera does not turn off automatically while it is connected to (communicating with) a computer. If the battery power runs out, the camera will stop whatever operation it is performing. This may result in a computer malfunction, or loss of image data (file) being transmitted.
- Do not turn the camera off while it is connected to the computer. Doing so could cause the computer to malfunction.
- Connecting the camera to a computer via a USB hub may cause unstable operation if there is any problem with compatibility between the computer and the hub. In this case, do not use a hub, but connect the camera directly to the computer.

Using OLYMPUS Master

For editing and managing image files, install the OLYMPUS Master software from the provided CD-ROM.

What is OLYMPUS Master?

OLYMPUS Master is application software for editing images taken with a digital camera on a computer. Installing it on your computer lets you do the following:

Download images from the camera or other media

Manage images

You can organize your images using the calendar display. Search the image you want by date or keyword.

View images and movies

You can run a slideshow and play back sound.

Edit images

You can rotate images, trim them and change the size.

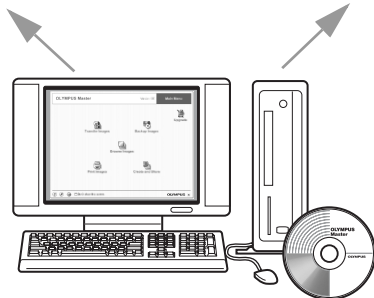

Edit images with the filter and correction functions

Make panoramic images

You can make panoramic images using pictures taken in panorama mode.

Print images

You can print images and make indexes, calendars and postcards.

For details of functions and operations other than the above, refer to the "Help" guide and OLYMPUS Master reference manual.

Installing OLYMPUS Master

Before installing the OLYMPUS Master software, please confirm that your computer is compatible with the following system requirements. For newer operating systems, please refer to the Olympus web site as shown on the back cover of this manual.

● Operating environment

Windows

OS	Windows 98SE/Me/2000 Professional/XP
CPU	Pentium III 500MHz or later
RAM	128 MB or more (at least 256 MB is recommended)
Hard disk capacity	300 MB or more
Connector	USB port
Monitor	1,024 × 768 pixels, 65,536 colors or more



Note

- Data transfer is only guaranteed on computers with a factory installed OS.
- To install the software in Windows 2000 Professional/XP, you must log on as a user with administrators' privileges.
- Internet Explorer and QuickTime 6 or later should be installed on your computer.
- Windows XP corresponds to Windows XP Professional/Home Edition.
- Windows 2000 corresponds to Windows 2000 Professional.
- If you are using Windows 98SE, the USB driver is installed automatically.

Macintosh

OS	Mac OS X 10.2 or later
CPU	Power PC G3 500 MHz or later
RAM	128 MB or more (at least 256 MB is recommended)
Hard disk capacity	300 MB or more
Connector	USB port
Monitor	1,024 × 768 pixels, 32,000 colors or more

Note

- Operation is only guaranteed on a Macintosh equipped with a built-in USB port.
- QuickTime 6 or later and Safari 1.0 or later must be installed.
- Be sure to remove the media (drag & drop onto the trash icon) before performing the following operations. Failure to do so could result in unstable computer operation and the need to reboot.
 - Disconnect the cable connecting the camera to the computer
 - Turn off the camera
 - Open the camera's card cover
 - Open the camera's battery compartment cover

Windows**1** Insert the CD-ROM into the CD-ROM drive.

- The OLYMPUS Master setup screen is displayed.
- If the screen is not displayed, double-click the "My Computer" icon and click the CD-ROM icon.

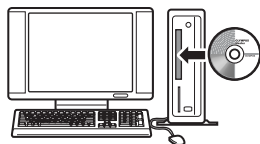
**2** Click the "OLYMPUS Master".

- The QuickTime installation screen is displayed.
- QuickTime is required to use OLYMPUS Master. If the QuickTime screen is not displayed, QuickTime 6 or later is already installed on the computer. In this case, go to step 4.

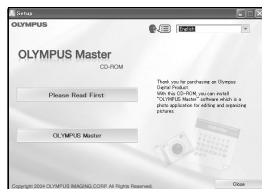

3 Click “Next” and follow the on-screen instructions.

- When the QuickTime licensing agreement is displayed, read the agreement and click “Agree” to proceed with the installation.
- The OLYMPUS Master installation screen is displayed.



4 Follow the on-screen instructions.

- When the OLYMPUS Master licensing agreement is displayed, read the agreement and click “Yes” to proceed with the installation.
- When the “User Information” dialog box is displayed, enter your “Name” and “OLYMPUS Master Serial Number”; select your region and click “Next”. Refer to the sticker on the CD-ROM package for the serial number.
- When the DirectX licensing agreement is displayed, read the agreement and click “Yes”.
- A screen asking whether or not you want to install Adobe Reader is displayed. Adobe Reader is required to read the OLYMPUS Master instruction manual. If this screen is not displayed, Adobe Reader is already installed on your computer.

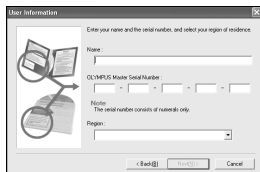
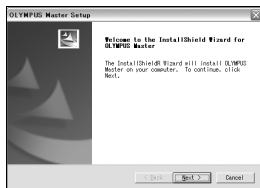

5 To install Adobe Reader, click “OK”.

- To cancel installation, click “Cancel”. Go to Step 7.
- The Adobe Reader installation screen is displayed. Follow the on-screen instructions.

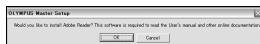

6 Follow the on-screen instructions.

- The screen confirming that installation is completed is displayed. Click "Finish".

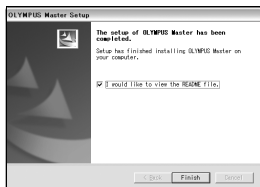

7 Select the option to restart immediately when the screen asking you if you wish to restart the computer is displayed and click "OK".

- The computer restarts.
- Remove the CD-ROM from the CD-ROM drive and store it.

Macintosh

1 Insert the CD-ROM into the CD-ROM drive.

- The CD-ROM window is displayed.
- If the CD-ROM window is not displayed, double-click the CD-ROM icon on the desktop.



2 Double-click on the desired language folder.

3 Double-click the "Installer" icon.

- The OLYMPUS Master installer starts up.
- Follow the on-screen instructions.
- When the OLYMPUS Master licensing agreement is displayed, read the agreement and click "Continue" and then "Agree" to proceed with the installation.
- The screen confirming that installation is completed is displayed.



4 Click "Finish".

- The first screen is displayed.

5 Click "Restart".

- The computer restarts.
- Remove the CD-ROM from the CD-ROM drive and store it.

Connecting the camera to a computer

Connect the cradle to the computer using the USB cable, and set the camera in the cradle.

1 Make sure the camera is turned off.

- The power lamp is off.
- The monitor is off.
- The lens barrier is closed.

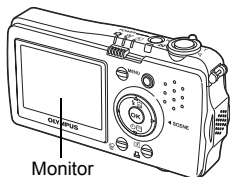

2 Plug the USB cable into the USB port on the computer.

- Refer to your computer's instruction manual to locate the position of the USB port.

3 Plug the USB cable into the cradle's USB connector.

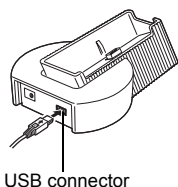

4 Set the camera in the cradle.

- The camera turns on automatically.
- The monitor turns on and the selection screen for the USB connection is displayed.

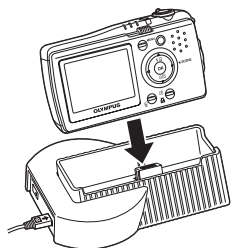

5 Select [PC], and press .

6 The camera is recognized by the computer.

- Windows 98SE/Me/2000
When you connect the camera to your computer for the first time, the computer attempts to recognize the camera. Click "OK" to exit the message that is displayed. The camera is recognized as a "Removable Disk".

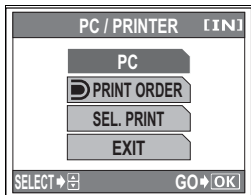

- Windows XP
When the camera is connected to the computer, the screen for selecting an image file operation is displayed. As OLYMPUS Master will be used to download images, click “Cancel”.
- Mac OS X
The iPhoto program is the default application for managing digital images. When you connect your digital camera for the first time, the iPhoto application starts automatically, so close this application and start OLYMPUS Master.

Note

- The camera functions are disabled while the camera is connected to a computer.

Starting up OLYMPUS Master

Windows

1 Double-click the “OLYMPUS Master” icon  on the desktop.

- The main menu is displayed.
- When OLYMPUS Master is started up for the first time after installation, the “Registration” dialog box is displayed before the main menu. Follow the prompts and fill in the registration form.

Macintosh

1 Double-click the “OLYMPUS Master” icon  in the “OLYMPUS Master” folder.

- The main menu is displayed.
- When OLYMPUS Master is started up for the first time, the “User Information” dialog box is displayed before the main menu. Enter your “Name” and “OLYMPUS Master Serial Number”, and select your region.
- After the “User Information” dialog box, the “Registration” dialog box is displayed. Follow the prompts and fill in the registration form.

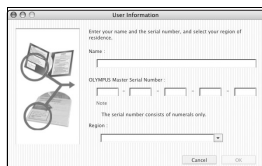

● OLYMPUS Master main menu

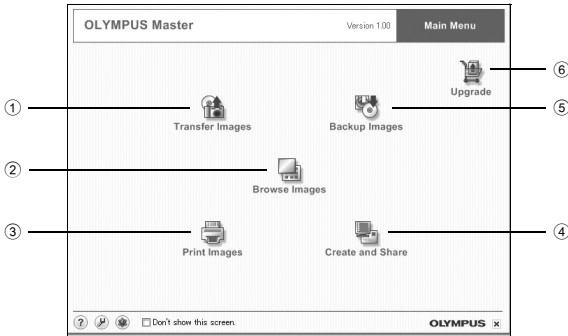

- ① **“Transfer Images” button**
Downloads images from the camera or other media.
- ② **“Browse Images” button**
Displays the browse window.
- ③ **“Print Images” button**
Displays the print menu.
- ④ **“Create and Share” button**
Displays the editing menu.
- ⑤ **“Backup Images” button**
Creates backup images.
- ⑥ **“Upgrade” button**
Displays window for optional upgrade to OLYMPUS Master Plus.

● To exit OLYMPUS Master

- 1 Click the **“Exit”**  on the main menu.
 - OLYMPUS Master is exited.

Displaying camera images on a computer

Downloading and saving images

You can save camera images on your computer.

1 Click “Transfer Images”  on the OLYMPUS Master main menu.

- The menu for selecting the source is displayed.

2 Click “From Camera” .

- The window for selecting images is displayed. All the images in the camera are displayed.

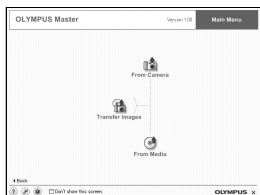

3 Select the image files and click “Transfer Images”.

- A window indicating that the download is complete is displayed.

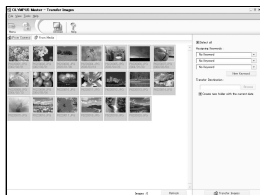

4 Click “Browse images now.”.

- The downloaded images are displayed in the browse window.
- To return to the main menu, click “Menu” in the “Browse” window.

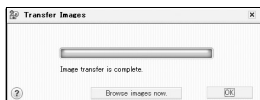

Note

- The self-timer/card access lamp blinks while downloading images. Do not do any of the following while the lamp is blinking.
 - Open the battery compartment/card cover.
 - Remove the camera from the cradle.
 - Connect or disconnect the AC adapter.

● To disconnect the camera

You can disconnect the camera after downloading the images to your computer. Also follow these steps when removing the camera from the cradle.

- 1 Make sure that the self-timer/
card access lamp is off.**

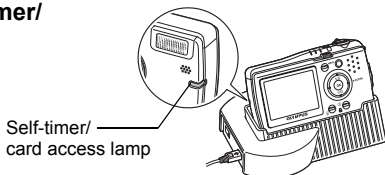

- 2 Make the following preparations
for disconnecting the USB
cable.**

Windows 98SE

- 1 Double-click the "My Computer" icon and right-click the "Removable Disk" icon to display the menu.
- 2 Click "Eject" on the menu.



Windows Me/2000/XP

- 1 Click the "Unplug or Eject Hardware" icon  in the system tray.
- 2 Click the message that is displayed.
- 3 When a message is displayed saying that the hardware can be ejected safely, click "OK".

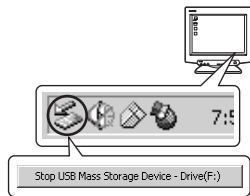

Macintosh

- 1 The trash icon changes to the eject icon when the "Untitled" or "NO_NAME" icon on the desktop is dragged. Drag and drop it on the eject icon.



3 Disconnect the USB cable from the cradle.

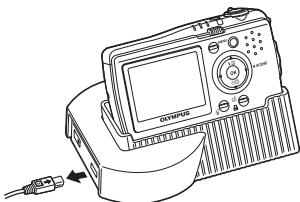

! Note

- Windows Me/2000/XP: When you click “Unplug or Eject Hardware”, a warning message may be displayed. Make sure that image data is not being downloaded from the camera and that all applications are closed. Click the “Unplug or Eject Hardware” icon again and disconnect the cable.

Viewing still pictures and movies

1 Click “Browse Images” on the OLYMPUS Master main menu.

- The “Browse” window is displayed.

2 Double-click the still picture thumbnail that you want to view.



- The camera switches to view mode and the picture is enlarged.
- To return to the main menu, click “Menu” in the “Browse” window.

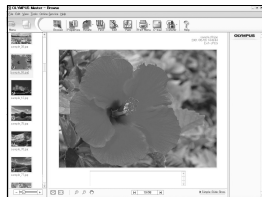

● To view a movie

1 Double-click the movie thumbnail that you want to see in the “Browse” window.

- The camera switches to view mode and the first frame of the movie is displayed.

2 To play back the movie, click playback button at the bottom of the screen.

The names and functions of the controller parts are shown below.



	Item	Description
1	Playback slider	Move the slider to select a frame.
2	Time display	Displays the time that has elapsed during playback.
3	Playback (pause) button	Plays the movie. Functions as the pause button during playback.
4	Back button	Displays the previous frame.
5	Forward button	Displays the next frame.
6	Stop button	Stops playback and returns to the first frame.
7	Repeat button	Plays the movie repeatedly.
8	Volume button	Displays the volume adjustment slider.

Printing pictures

Pictures can be printed from the photo, index, postcard and calendar menus. The explanation below uses the photo menu.

1 Click “Print Images” on the OLYMPUS Master main menu.

- The print menu is displayed.

2 Click “Photo” .

- The “Photo Print” window is displayed.

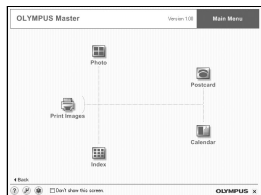

3 Click “Settings” in the “Photo Print” window.

- The printer settings screen is displayed. Make the necessary printer settings.

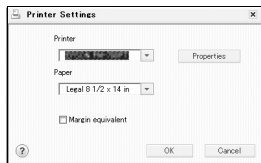

4 Select a layout and size.

- To print the date and time with your image, check the box next to “Print Date”, and select between “Date” and “Date & Time”.

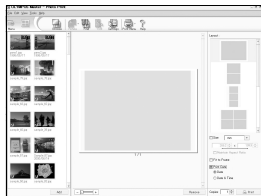

5 Select the thumbnail image that you want to print and click “Add”.

- A preview of the selected image is displayed on the layout.

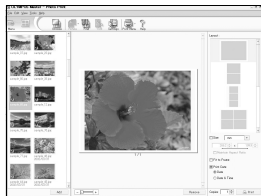

6 Select the number of copies.

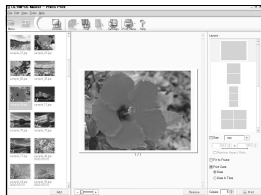

7 Click "Print".

- Printing starts.
- To return to the main menu, click "Menu" in the "Photo Print" window.

To download and save images to a computer without using OLYMPUS Master

This camera is compatible with USB mass storage. You can connect the camera to your computer using the USB cable provided with the camera to download and save images without using OLYMPUS Master. The following environment is required to use the USB cable to connect the camera to your computer.

Windows: Windows 98SE/Me/2000 Professional/XP

Macintosh: Mac OS 9.0 to 9.2/X

Note

- If your computer is running Windows 98SE, you will need to install the USB driver. Before connecting the camera to your computer with the USB cable, double-click the files from the following folders on the OLYMPUS Master CD-ROM provided.
(Drive name):\USB\INSTALL.EXE
- Data transfer is not guaranteed in the following environments, even if your computer is equipped with a USB port.
 - Windows 95/98/NT 4.0
 - Windows 98SE upgrades from Windows 95/98
 - Mac OS 8.6 or earlier (However, data transfer is confirmed on Mac OS 8.6 equipped with a factory-installed USB port and USB MASS Storage Support 1.3.5.)
 - Computers with a USB port added by means of an extension card, etc.
 - Computers without a factory-installed OS and home-built computers.

Appendix





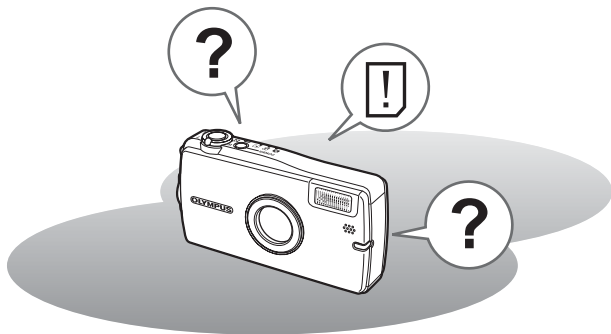



This chapter contains useful information from OLYMPUS.

Here you will find what to do when you are stuck or don't understand the meaning of the terms used in this manual. Refer to this section for basic troubleshooting, camera care and a full glossary to understanding the terms used in this manual.



Troubleshooting

Error messages

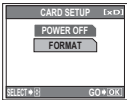
Monitor indication	Possible cause	Corrective action
 CARD ERROR	There is a problem with the card.	This card cannot be used. Insert a new card.
 WRITE-PROTECT	Writing to the card is prohibited.	The recorded image has been protected (read-only) on a computer. Download the image to a computer and cancel the read-only setting.
 MEMORY FULL	The internal memory has no available memory and cannot store any new data.	Back up all data to a card or erase unwanted data. Before erasing, download important data to a computer.
 CARD FULL	The card has no available memory and cannot store any new data.	Replace the card or erase unwanted data. Before erasing, download important data to a computer.
 NO PICTURE	There are no pictures in the internal memory or on the card.	The internal memory or the card contains no pictures. Record pictures.
 PICTURE ERROR	There is a problem with the selected picture and it cannot be played back on this camera.	Use image processing software to view the picture on a computer. If that cannot be done, the image file is damaged.
 CARD-COVER OPEN	The battery compartment/card cover is open.	Close the battery compartment/card cover.
 Y/M/D	When the camera is used for the first time or the battery has been removed for a long time, the date and time are on the factory default setting.	Set the date and time.
	This card cannot be used with this camera or the card is not formatted.	<ul style="list-style-type: none"> • Replace or format the card. • Select [POWER OFF] and press \odot. Insert a new card. • Select [FORMAT] and press \odot. All data on the card is erased.

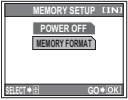

Monitor indication	Possible cause	Corrective action
	<p>There is an error in the internal memory.</p>	<p>Select [MEMORY FORMAT] and press OK. All data in the internal memory is erased. Frames and titles used to compose images are erased. Use OLYMPUS Master to add them in again.</p>

Troubleshooting

● Preparatory operations

Possible cause	Corrective action	Ref. page
The camera does not turn on or function buttons do not respond.		
The power is off.	Press the POWER switch to turn the camera on.	–
The battery power is exhausted.	Charge the battery.	–
The battery is temporarily unable to function because of the cold.	Warm the battery by putting it in your pocket for a while.	–
The camera is in the sleep mode.	Operate the camera with the shutter button or zoom lever.	–
The camera is connected to a computer.	The camera will not operate while it is connected to a computer.	–

● Shooting

Possible cause	Corrective action	Ref. page
No picture is taken when the shutter button is pressed.		
The battery power is exhausted.	Charge the battery.	–
The camera is in the playback mode.	Set the mode switch to a mode other than  .	P. 10
The flash has not finished charging.	Remove your finger from the shutter button, and wait until the orange lamp and  (flash charge) indication stop blinking before taking the picture.	P. 38
The power is off.	Press the POWER switch.	–
The internal memory or card is full.	Erase unwanted pictures or insert a new card. Before erasing, download important images to a computer.	P. 79, 138
The battery ran out of power during shooting or while the images were being written to the internal memory or the card.	Charge the battery. (Wait until the self-timer/ card access lamp turns off when blinking.)	–
The memory gauge is full.	Wait until there is space in the memory gauge.	–
There is a problem with the card.	See “Error messages”.	P. 145

Possible cause	Corrective action	Ref. page
The monitor is hard to see.		
There is condensation* inside the camera.	Turn the camera off and wait until it dries before turning it on again.	–
The brightness of the monitor is not adjusted properly.	Use [] to adjust the brightness.	P. 100
The monitor is exposed to direct sunlight.	Block the sunlight with your hand.	–
Vertical lines appear on the monitor screen during shooting.	Aiming the camera at a bright subject in sunlight may cause vertical lines to appear on the screen. This is not a malfunction.	–
The date recorded with the image data is wrong.		
The date/time is not set.	Set the date and time. The clock adjustment is not factory-preset.	P. 101
The camera has been left without the battery.	If the camera is left without the battery for 1 day, the date/time setting is canceled. Set the date/time again.	P. 101
The settings are returned to the factory default settings when the camera is turned off.		
[ALL RESET] is set to [ON].	Set [ALL RESET] to [OFF].	P. 93
The picture is out of focus.		
The subject was too close.	Move further away from the subject. To take pictures closer than 10 cm (3.9") with the zoom in the maximum wide position, use the super macro mode.	P. 37
Auto focus is not possible.	Use the focus lock to focus on the subject.	P. 22
There is condensation* inside the camera.	Turn the camera off and wait until it dries before turning it on again.	–
The monitor goes off.		
The camera is in the sleep mode.	Operate the camera with the shutter button or zoom lever.	–

Possible cause	Corrective action	Ref. page
The flash does not fire.		
The subject is illuminated.	If you want the flash to fire on a brightly illuminated subject, set the flash to [⚡].	P. 38
Sequential shooting is set.	The flash does not fire in the sequential shooting mode. Set [📷] to [OFF].	P. 43
The camera records movies.	The flash does not fire in the movie mode. Select a shooting mode other than 📹.	P. 40
Super macro mode is set.	The flash does not fire in the super macro mode. Set [🌸] to [OFF] or [🌸].	P. 37
Panorama mode is set.	The flash does not fire in the panorama mode. Cancel panorama mode.	P. 50
The battery run time is brief.		
You are using the camera in a cold environment.	Battery performance deteriorates in low temperatures. Keep the camera warm by putting it inside your coat or clothing.	–
The remaining battery power is not indicated correctly.	When battery consumption fluctuates considerably, the camera may turn off without displaying the battery warning indicator. Charge the battery.	–

* Condensation: When it is cold outside, the water vapor in the air is rapidly cooled and turns to droplets of water. Condensation occurs when the camera is suddenly taken from a cold place into a warm room.

● Playback of recorded images

Possible cause	Corrective action	Ref. page
The pictures in the internal memory cannot be played back.		
The card is inserted in the camera.	When a card is inserted, only pictures on the card can be played back. Remove the card.	P. 28

Possible cause	Corrective action	Ref. page
The picture is out of focus.		
A subject unsuited to AF was taken.	Use the focus lock to focus on the subject.	P. 22
The camera moved when the shutter button was pressed.	Hold the camera correctly and press the shutter button gently. Camera movement occurs easily with slower shutter speeds. When you take a picture with [Ⓢ] in a night scene or a dark situation, use a tripod, or hold the camera firmly.	–
The lens was dirty.	Clean the lens. Use a commercially available blower brush and then wipe with a lens cleaner to remove dust. Mold may form on the lens surface if the lens is left dirty.	P. 153
The picture is too bright.		
The flash was set to [⚡].	Select a flash mode other than [⚡].	P. 38
The center of the subject is too dark.	If the center of the subject is too dark, the surrounding area emerges as too bright. Adjust the exposure compensation toward minus (-).	P. 45
The picture is too dark.		
The flash was blocked by your finger.	Hold the camera correctly, keeping your fingers away from the flash.	–
The subject was out of the working range of the flash.	Shoot within the flash working range.	P. 38
The subject was too small and was backlit.	Set the flash to [⚡], or use the spot metering mode.	P. 38, 47
The sequential shooting mode was used.	Higher shutter speeds are used during sequential shooting, which may result in pictures that are darker than usual. Set [📷] to [OFF].	P. 43
The center of the subject is too bright.	If the center of the subject is too bright, the image as a whole emerges darker. Adjust the exposure compensation toward plus (+).	P. 45

Possible cause	Corrective action	Ref. page
The colors of pictures look unnatural.		
Indoor lighting affected the picture's colors.	Set the white balance according to the lighting.	P. 46
No white in the picture.	Include something white in the picture, or shoot using [⚡].	P. 38
The white balance setting is wrong.	Adjust the white balance according to the light source.	P. 46
Part of the picture is dark.		
The lens was partly blocked by your finger or the strap.	Hold the camera correctly, keeping your fingers and the strap away from the lens.	–
Pictures you have taken do not appear on the monitor.		
The power is off.	Set the mode switch to [▶], then press the POWER switch to turn the camera on.	P. 10
The camera is in the shooting mode.	Set the mode switch to [▶].	P. 10
There are no pictures in the internal memory or on the card.	[NO PICTURE] is displayed on the monitor. Record pictures.	–
There is a problem with the card.	See "Error messages".	P. 145
The camera is connected to a TV.	The monitor does not function when the AV cable is connected to the camera.	P. 76
Single-frame erase and all-frame erase cannot be performed.		
The pictures are protected.	Cancel the protection of the pictures.	P. 77
No picture is displayed on the TV when connected to the camera.		
The video output signal is incorrect.	Set the video output signal according to the region where used.	P. 77
The TV video signal setting is incorrect.	Set the TV to the video input mode.	–
The monitor is hard to see.		
The brightness of the monitor is not adjusted properly.	Use [☀] to adjust monitor brightness.	P. 100
The monitor is exposed to direct sunlight.	Block the sunlight with your hand.	–

● When the camera is connected to a computer or printer

Possible cause	Corrective action	Ref. page
The printer fails to connect.		
PC was selected on the monitor after connecting the camera to the printer with the USB cable.	Remove the USB cable, and start again from Step 1 of "Printing pictures".	P. 117
The printer does not support PictBridge.	Refer to the printer's instruction manual or contact the manufacturer.	–
The camera is not recognized by the computer.		
The computer failed to recognize the camera.	Disconnect the USB cable from the cradle, and connect it again.	P. 135
The USB driver has not been installed.	Install OLYMPUS Master.	P. 130

● When using Dock&Done-compatible devices

Possible cause	Corrective action	Ref. page
Pictures from the camera cannot be saved in the storage unit.		
The storage unit is not turned on.	Turn the storage unit on.	P. 105
The mode switch on the storage unit is set to [PC].	To save pictures from the camera directly to the unit, set to  DOCK].	P. 105
The [STORE] setting is set to [NOT STORE].	Set it to [STORE].	P. 113
The printer fails to print.		
The printer is not turned on.	Turn the printer on.	P. 110
The printer is connected to the storage unit (hard disk or DVD) with the USB cable.	Use the optional Dock&Done cable to connect the printer to the storage unit (hard disk or DVD).	P. 110

Camera care

● Cleaning the camera

Exterior:

- Wipe gently with a soft cloth. If the camera is very dirty, soak the cloth in mild soapy water and wring well. Wipe the camera with the damp cloth and then dry it with a dry cloth. If you have used the camera at the beach, use a cloth soaked in clean water and wrung well.

Monitor

- Wipe gently with a soft cloth.

Lens

- Blow dust off the lens with a commercial blower, then wipe gently with a lens cleaner.

Cradle

- Blow dust off the terminals with a commercial blower. Never allow the terminals to become wet.

Battery

- Wipe gently with a soft, dry cloth.

Note

- Do not use strong solvents such as benzene or alcohol, or chemically treated cloth.
- Mold may form on the lens surface if the lens is left dirty.

● Storage

- When storing the camera for extended periods, remove the battery, AC adapter and card, and keep in a cool, dry place that is well ventilated.
- Periodically insert the battery and test the camera functions.

Note

- Avoid leaving the camera in places where chemical products are handled since this may result in corrosion.

AC adapter

An AC adapter is useful for time-consuming tasks such as image downloads to a computer.

Use the supplied Olympus AC adapter (A511) to power your digital camera from a common AC wall outlet. Do not use any other AC adapter with this camera.

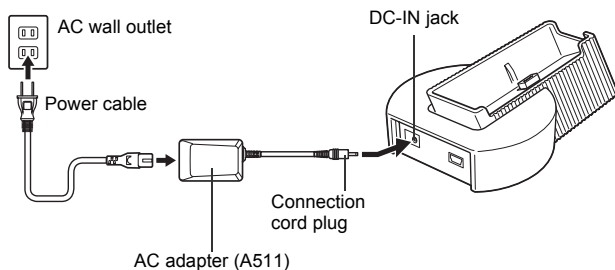

? TIPS

- When the AC adapter is connected, pressing the **POWER** switch turns the camera on in playback mode regardless of the position of the mode switch.
- If you use the AC adapter when the camera is turned on, the battery in the camera will be charged.
- The battery charges in approximately 2 hours.
- The power lamp slowly flashes while the battery is charging.
- When the cradle is docked with a Dock&Done storage unit (hard disk or DVD), the camera is charged via the unit. Turn the camera off.

! Note

- If the battery power runs out while the camera is connected to a computer or printer, the image data may be lost or damaged. It is recommended that you use the supplied AC adapter when connecting the camera to a computer or printer. Do not connect or disconnect the AC adapter while the camera is connected to a computer or printer.
- Do not remove or load the battery or connect or disconnect the AC adapter while the camera is turned on. Doing so could affect the camera's internal settings or functions.
- If an error occurs while the battery in the camera is charging, the power lamp lights red. Check that the battery and plug are inserted correctly.

Safety Precautions

Caution for Usage Environment

- To protect the high-precision technology contained in this product, never leave the camera in the places listed below, no matter if in use or storage:
 - Places where temperatures and/or humidity are high or go through extreme changes. Direct sunlight, beaches, locked cars, or near other heat sources (stove, radiator, etc.) or humidifiers.
 - In sandy or dusty environments.
 - Near flammable items or explosives.
 - In wet places, such as bathrooms or in the rain. When using products with weatherproof designs, read their manuals as well.
 - In places prone to strong vibrations.
- Never drop the camera or subject it to severe shocks or vibrations.
- When mounted on a tripod, adjust the position of the camera with the tripod head. Do not twist the camera.
- Do not touch electric contacts on cameras.
- Do not leave the camera pointed directly at the sun. This may cause lens or shutter curtain damage, color failure, ghosting on the CCD, or may possibly cause fires.
- Do not push or pull severely on the lens.
- Before storing the camera for a long period, remove the battery. Select a cool, dry location for storage to prevent condensation or mold from forming inside the camera. After storage, test the camera by turning it on and pressing the shutter release button to make sure that it is operating normally.
- Always observe the operating environment restrictions described in the camera's manual.

Battery Handling Precautions

- This camera uses a lithium ion battery specified by Olympus. Do not use any other type of battery. For safe and proper use, read the battery's instruction manual carefully before using it.
- If the battery's terminals get wet or greasy, camera contact failure may result. Wipe the battery well with a dry cloth before use.
- Always charge a battery when using it for the first time, or if it has not been used for a long period.
- When operating the camera with battery power at low temperatures, try to keep the camera and spare battery as warm as possible. A battery that has run down at low temperatures may be restored after it is warmed at room temperature.
- The number of pictures you can take may vary depending on the shooting conditions or battery.
- Before going on a long trip, and especially before traveling abroad, purchase extra batteries. A recommended battery may be difficult to obtain while traveling.
- Please recycle batteries to help save our planet's resources. When you throw away dead batteries, be sure to cover their terminals and always observe local laws and regulations.

AC Adapter Precautions

- Use an AC adapter designed to operate on the AC voltage in the area the camera is being used.
- The AC adapter is exclusively for indoor use.
- Turn off the camera when disconnecting any power cables from the plug or wall outlet. Not doing so could affect the camera's internal settings or functions.
- The AC adapter may become hot when used, but this does not indicate a product malfunction.
- The AC adapter may emit a beeping sound, but this does not indicate a product malfunction.
- When using the AC adapter near a radio, your radio may experience electrical frequency interference. Keep the adapter as far from the radio as possible.

LCD Monitor

- Do not push the monitor forcibly; otherwise the image may become vague, resulting in a playback mode failure or damage to the monitor.
- A strip of light may appear on the top/bottom of the monitor, but this is not a malfunction.
- When a subject is viewed diagonally in the camera, the edges may appear zigzagged on the monitor. This is not a malfunction; it will be less noticeable in playback mode.
- In places subject to low temperatures, the LCD monitor may take a long time to turn on or its color may change temporarily. When using the camera in extremely cold places, it is a good idea to occasionally place it in a warm place. An LCD monitor exhibiting poor performance due to low temperatures will recover in normal temperatures.
- The LCD used for the monitor is made with high-precision technology. However, black spots or bright spots of light may appear constantly on the LCD Monitor. Due to its characteristics or the angle at which you are viewing the monitor, the spot may not be uniform in color and brightness. This is not a malfunction.

Legal and Other Notices

- Olympus makes no representations or warranties regarding any damages, or benefit expected by using this unit lawfully, or any request from a third person, which are caused by the inappropriate use of this product.
- Olympus makes no representations or warranties regarding any damages or any benefit expected by using this unit lawfully which are caused by erasing picture data.

Disclaimer of Warranty

- Olympus makes no representations or warranties, either expressed or implied, by or concerning any content of these written materials or software, and in no event shall be liable for any implied warranty of merchantability or fitness for any particular purpose or for any consequential, incidental or indirect damages (including but not limited to damages for loss of business profits, business interruption and loss of business information) arising from the use or inability to use these written materials or software or equipment. Some countries do not allow the exclusion or limitation of liability for consequential or incidental damages, so the above limitations may not apply to you.
- Olympus reserves all rights to this manual.

Warning

Unauthorized photographing or use of copyrighted material may violate applicable copyright laws. Olympus assumes no responsibility for unauthorized photographing, use or other acts that infringe upon the rights of copyright owners.

Copyright Notice

All rights reserved. No part of these written materials or this software may be reproduced or used in any form or by any means, electronic or mechanical, including photocopying and recording or the use of any type of information storage and retrieval system, without the prior written permission of Olympus. No liability is assumed with respect to the use of the information contained in these written materials or software, or for damages resulting from the use of the information contained therein. Olympus reserves the right to alter the features and contents of this publication or software without obligation or advance notice.

FCC Notice

- **Radio and Television Interference**

Changes or modifications not expressly approved by the manufacturer may void the user's authority to operate this equipment. This equipment has been tested and found to comply with the limits for a Class B digital device, pursuant to Part 15 of the FCC Rules. These limits are designed to provide reasonable protection against harmful interference in a residential installation.

This equipment generates, uses, and can radiate radio frequency energy and, if not installed and used in accordance with the instructions, may cause harmful interference to radio communications.

However, there is no guarantee that interference will not occur in a particular installation. If this equipment does cause harmful interference to radio or television reception, which can be determined by turning the equipment off and on, the user is encouraged to try to correct the interference by one or more of the following measures:

- Adjust or relocate the receiving antenna.
- Increase the distance between the camera and receiver.
- Connect the equipment to an outlet on a circuit different from that to which the receiver is connected.
- Consult your dealer or an experienced radio/TV technician for help. Only the OLYMPUS-supplied USB cable should be used to connect the camera to USB enabled personal computers (PC).

Any unauthorized changes or modifications to this equipment would void the user's authority to operate.

CCD (Charge-Coupled Device)

This converts light passing through the lens into electrical signals. On this camera, light is picked up and converted into RGB signals to build a single image.

Contrast Detection Method

This is used to measure the distance to the subject. The camera determines if the image is focused by the level of contrast in the subject.

DCF (Design Rule for Camera File System)

A standard for image files by the Japan Electronics and Information Technology Industries Association (JEITA).

DPOF (Digital Print Order Format)

This is for saving desired print settings on digital cameras. By entering which images to print and the number of copies of each, the user can easily have the desired images printed by a printer or print lab that supports the DPOF format.

Eclipsing (Vignetting)

This refers to when an object obscures part of the field of view so that the whole subject is not photographed. Vignetting also refers to when the image seen through the viewfinder does not exactly match the image shot through the objective lens, so the photographed image includes objects not seen through the viewfinder. In addition, vignetting can occur when an incorrect lens hood is used, causing shadowing to appear in the corners of the image.

ESP (Electro-Selective Pattern) Light Metering/Digital ESP Light Metering

This determines the exposure by metering and calculating the light levels in the center and other areas of the image separately.

EV (Exposure Value)

A system for measuring exposure. EV0 is when the aperture is at F1 and the shutter speed is 1 second. The EV then increases by 1 each time the aperture increases by one F stop or the shutter speed increases by one increment. EV can also be used to indicate brightness and ISO settings.

Exposure

The amount of light used to capture an image. The exposure is determined by the time the shutter is open (shutter speed) and the amount of light that passes through the lens (aperture).

Images size

The size of an image expressed by the number of pixels that make up the image. For instance, a picture taken with an image size of 640 × 480 fills the computer screen when the monitor setting is 640 × 480. However, if the monitor setting is 1,024 × 768, the picture only takes up part of the screen.

Noise reduction

When shooting in dark places, shutter speeds become slower as there is less light focused on the CCD. During long exposures, signals are generated by parts of the CCD where no light is focused and are recorded on the picture as noise. When noise reduction works, the camera automatically reduces the noise to produce clearer images.

NTSC (National Television Systems Committee) / PAL (Phase Alternating Line)

Television formats. NTSC is mainly used in Japan, North America and Korea. PAL is mainly used in Europe and China.

PictBridge

A standard for connecting digital cameras and printers of different makers and printing out pictures directly.

Pixels

A pixel is the smallest unit (dot) used to make up an image. Clear large-sized printed images require millions of pixels.

P-AUTO (Program auto) Mode

Also called Program AE mode. The camera automatically sets the best shutter speed and aperture for the shot.

Sleep Mode

A mode designed to save battery life. The camera automatically enters the sleep mode if you do not operate it for a certain time. To exit the sleep mode, use any button on the camera (shutter button, arrow pad, etc.).

TFT (Thin-Film Transistor) Color Monitor

A transistor color monitor constructed using thin-film technology.

Menu list

● Shooting mode menus (📷)

Top menu	Item	Setting	Ref. page
MODE MENU		[SH] SUPER HIGH 5M, [H1] HIGH 3M, [H2] HIGH 2M, [B] BASIC 1M, [X] E-MAIL VGA	P. 24
		OFF, ON	P. 43
		-2.0 – +2.0	P. 45
	DIGITAL ZOOM	OFF, ON	P. 36
	WB	AUTO, , , ,	P. 46
	METERING	AUTO,	P. 47
	AF MODE	AUTO, SPOT	P. 48
	PANORAMA		P. 50
	2 IN 1		P. 52
	FRAME MODE		P. 53
	(still pictures)	OFF, ON	P. 54
	MEMORY FORMAT(FORMAT)	YES, NO	P. 80
	SETUP		P. 168
	VOICE REC		P. 89
	OFF, ,	P. 37	
SCENE SELECT	P-AUTO , , , , , , , , , , , ,	P. 32	







● Shooting mode menus (📷)

Top menu	Item	Setting	Ref. page
MODE MENU		STANDARD, EXTENDED	P. 24
		-2.0 – +2.0	P. 45
	DIGITAL ZOOM	OFF, ON	P. 36
	WB	AUTO, , , ,	P. 46
	FULLTIME AF	OFF, ON	P. 42
	(movies)	OFF, ON	P. 42
	MEMORY FORMAT(FORMAT)	YES, NO	P. 80
	SETUP		P. 168
VOICE REC			P. 89
		OFF, ,	P. 37
IMAGE STABILIZER		OFF, ON	P. 41



● Shooting mode menus (📷) in [VOICE REC]

Top menu	Item	Setting	Ref. page
VOICE REC. END			P. 89
VOICE QUALITY		FINE, STANDARD, EXTENDED	P. 90
MONITOR		ON, OFF	P. 90

● Playback mode menus (▶) (still pictures)



Top menu	Item	Setting	Ref. page
MODE MENU		+90°, 0°, -90°	P. 58
		START	P. 64
	EDIT	BLACK & WHITE, SEPIA,  , 	P. 65
	FIX IMAGE	REDEYE FIX, BRIGHTNESS, SATURATION	P. 66
	COMPOSE IMAGE	FRAME, TITLE, CALENDAR, LAYOUT	P. 68
		OFF, ON	P. 77
	ERASE	ERASE, ALL ERASE	P. 79
	MEMORY FORMAT (FORMAT)	YES, NO	P. 80
	ALBUM ENTRY		P. 82
	STORE	STORE, NOT STORE	P. 105
	CREATE SHARE DISK	START	P. 108
	SETUP		P. 168
STORAGE		P. 107	
INFO		NO INFO, STANDARD, DETAIL	P. 61
		STANDARD, SCROLL, FADER, ZOOM DOWN, ZOOM UP, CHECKERBOARD, BLINDS, SWIVEL, RANDOM	P. 62

● Playback mode menus (▶) (movies)

Top menu	Item	Setting	Ref. page
MODE MENU	INDEX PLAY		P. 60
	EDIT	NEW FILE, OVERWRITE	P. 73
	INDEX	YES, RESET, CANCEL	P. 74
	 ON	OFF, ON	P. 77
	ERASE	ERASE, ALL ERASE	P. 79
	MEMORY FORMAT(FORMAT)	YES, NO	P. 80
	ALBUM ENTRY		P. 82
	STORE	STORE, NOT STORE	P. 113
	CREATE SHARE DISK	START	P. 108
	SETUP		P. 168
STORAGE			P. 107
INFO		NO INFO, STANDARD, DETAIL	P. 61
		STANDARD, SCROLL, FADER, ZOOM DOWN, ZOOM UP, CHECKERBOARD, BLINDS, SWIVEL, RANDOM	P. 62

* Depending on the playback status, [STOP] may be displayed.

● Playback mode menus (▶) (calendar display)

Top menu	Item	Setting	Ref. page
MODE MENU		+90°, 0°, -90°	P. 58
	INDEX PLAY		P. 60
		OFF, ON	P. 77
	ERASE	ERASE, ALL ERASE	P. 79
	MEMORY FORMAT(FORMAT)	YES, NO	P. 80
	SETUP		P. 168
CLOSE CALENDAR			P. 57
INFO		NO INFO, STANDARD, DETAIL	P. 61
		STANDARD, SCROLL, FADER, ZOOM DOWN, ZOOM UP, CHECKERBOARD, BLINDS, SWIVEL, RANDOM	P. 62

● Playback mode menus (▶) (album display)



Top menu	Item	Setting	Ref. page
MODE MENU		STANDARD, SCROLL, FADER, ZOOM DOWN, ZOOM UP, CHECKERBOARD, BLINDS, SWIVEL, RANDOM	P. 62
	INDEX PLAY		P. 60
	REARRANGE		P. 85
	UNDO ENTRY		P. 86
	UNDO ALL	YES, NO	P. 86
	ERASE	ERASE	P. 87
	SETUP		P. 168
SEL. ALBUM*			P. 84
INFO		NO INFO, STANDARD, DETAIL	P. 61
CLOSE ALBUM			P. 84

* Depending on the playback status, [STOP] or [END PLAYBACK] may be displayed.

● Playback mode menus (▶) (voice)

Top menu	Item	Setting	Ref. page
MODE MENU		OFF, ON	P. 77
	ERASE	ERASE, ALL ERASE	P. 79
	MEMORY FORMAT(FORMAT)	YES, NO	P. 80
	ALBUM ENTRY		P. 82
	STORE	STORE, NOT STORE	P. 113
	SETUP		P. 168
STORAGE			P. 107
INFO		NO INFO, STANDARD, DETAIL	P. 61
END PLAYBACK			P. 91





● Playback mode menus (▶) (storage)

Top menu	Item	Setting	Ref. page
CLOSE STORAGE			P. 107
 ^{*1}		+90°, 0°, -90°	P. 58
 ^{*2}		STANDARD, SCROLL, FADER, ZOOM DOWN, ZOOM UP, CHECKERBOARD, BLINDS, SWIVEL, RANDOM	P. 62
 ^{*2}		ON, OFF	P. 77

*1 If the top menu is displayed in calendar display, [] is not available. [ALL ERASE] is displayed instead of [].

*2 Depending on the playback status, [STOP] or [END PLAYBACK] may be displayed.

● PRINT menus (▶) (when is pressed)

Top menu	Item	Setting	Ref. page
FIX IMAGE		REDEYE FIX, BRIGHTNESS, SATURATION, BLACK&WHITE, SEPIA,  , CANCEL	P. 65, 66
COMPOSE IMAGE		FRAME, TITLE, CALENDAR, LAYOUT, CANCEL	P. 68
PRINT IMAGE			P. 116
		 ,  , ALBUM, CHECK/CANCEL	P. 124

● SETUP menu (for both shooting mode and playback menus)















Item	Setting	Ref. page
ALL RESET	OFF, ON	P. 93
 *1		P. 94
SCREEN	OFF, 1, 2	P. 94
SLEEP	30SEC, 1MIN, 3MIN, 5MIN, 10MIN	P. 95
 CUSTOM BUTTON	 , SCENE SELECT,  ,  ,  , DIGITAL ZOOM, WB, METERING, AF MODE, FULLTIME AF,  (still pictures),  (movies), IMAGE STABILIZER	P. 96
	OFF, ON	P. 98
SHUTTER SOUND	OFF, 1, 2	P. 98
BEEP	OFF, 1, 2	P. 98
REC VIEW	OFF, ON	P. 99
FILE NAME	RESET, AUTO	P. 99
PIXEL MAPPING	START	P. 103
		P. 100
		P. 101
VOLUME		P. 98
VIDEO OUT	NTSC, PAL	P. 77
BACKUP	YES, NO	P. 78
STORE AND	ERASE, KEEP	P. 113
PRINT AND	CANCEL, KEEP	P. 114
NEW ALL PRINT	OFF, ON	P. 114
MODE RESET	YES, NO	P. 102

*1 Available languages vary depending on the area where you purchased this camera.



List of factory default settings

The functions are set as follows when the camera leaves the factory.





● Shooting mode

Zoom	38 mm
Monitor	ON
	0.0
FLASH MODE	 : AUTO  : 
	OFF
METERING	AUTO
	OFF
	OFF
SCENE	P-AUTO
DIGITAL ZOOM	OFF
IMAGE STABILIZER	OFF
FULLTIME AF	OFF
AF MODE	AUTO
PANORAMA	OFF
2 IN 1	OFF
FRAME MODE	OFF
 (still pictures)	OFF
 (movies)	ON
	 :  SUPER HIGH 5M  :  STANDARD
WB	AUTO
REC VIEW	ON
FILE NAME	RESET
CUSTOM BUTTON	
SHUTTER SOUND	1 - LOW
VOICE QUALITY	STANDARD
MONITOR (VOICE REC)	ON

● Playback modes













INFO	STANDARD
	0°
	STANDARD
	OFF
VOLUME	3



● Others

ALL RESET	OFF
	ENGLISH
SCREEN	1
	NORMAL
	Y-M-D 2005.01.01 00:00
VIDEO OUT	NTSC or PAL ^{*1}
	ON - LOW
BEEP	1 - LOW
SLEEP	3MIN
STORE AND	KEEP
PRINT AND	KEEP
NEW ALL PRINT	OFF











*1 Settings differ according to the region where the camera is sold.

Modes and shooting functions

Function	Mode 		
	P-AUTO	SCENE	
Zoom		✓	✓*1
DIGITAL ZOOM		✓	
AF MODE		✓	—
FULLTIME AF		—	✓
FLASH MODE	✓	✓*2	—
		✓	
		✓	
		✓*3	✓
	✓	✓*4	—
 (still pictures)		✓*5	—
 (movies)		—	✓
IMAGE STABILIZER		—	✓
PANORAMA		✓	—
2 IN 1		✓	—
FRAME MODE		✓	—
		✓	
METERING		✓	—
		✓	
WB		✓	
ALL RESET		✓	
		✓	
SCREEN		✓	
REC VIEW		✓	—
FILE NAME		✓	
PIXEL MAPPING		✓	
		✓	
		✓	
VIDEO OUT		✓	
CUSTOM BUTTON		✓	

Function \ Mode			
	P-AUTO	SCENE	
		✓	
SHUTTER SOUND		✓	
BEEP		✓	
STORE AND		✓	
PRINT AND		✓	
NEW ALL PRINT		✓	

✓: Available —: Not available

- *1 When [ (movies)] is set to [OFF].
- *2 Cannot be selected in [, [, [] or [] mode.
- *3 Cannot be selected during panorama shooting.
- *4 Cannot be selected in [, [, [, [, [] or [] mode.
- *5 Cannot be selected during panorama shooting.

Names of parts

Camera

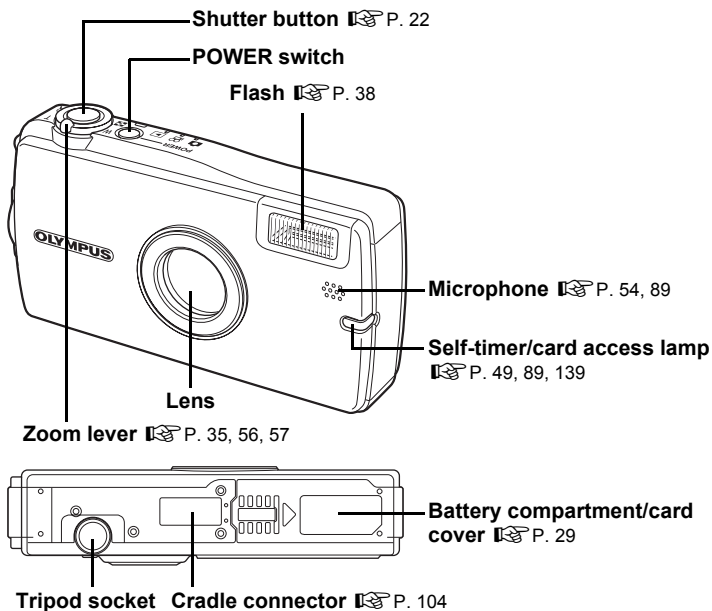

Status	Power lamp	Status	Power lamp
Camera on	Lit (green)	Voice playback paused	Blinking (purple)
Camera off or sleep mode	Off	Connected to or printing with PictBridge printer	Lit (light blue)
Charging (camera on)	Blinking (green)	Connected to USB	Lit (green)
Charging (camera off)	Blinking (red)	Connected to Dock&Done or storage playback	Lit (blue)
Charging error	Blinking intermittently (red)	Dock&Done store, print, or remote control reception	Blinking (blue)
VOICE mode or voice recording	Lit (purple)		

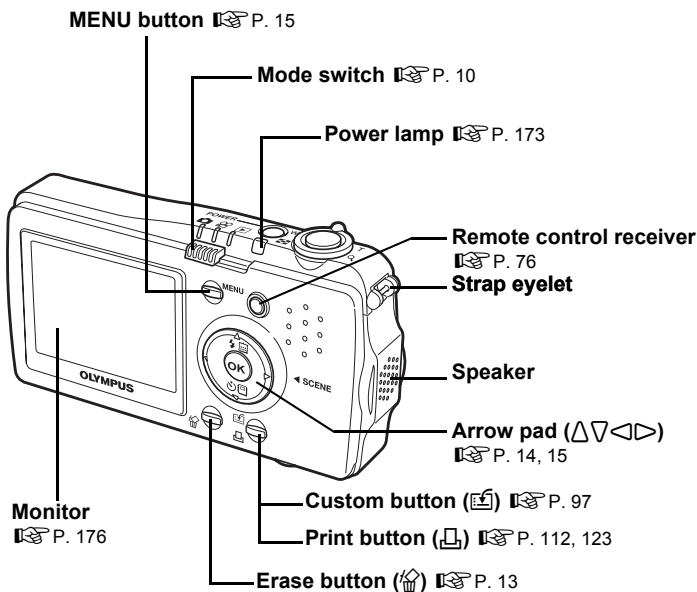

Arrow pad

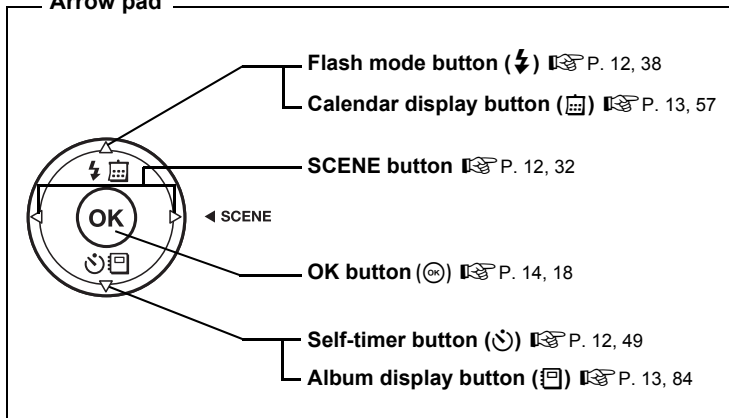

Cradle

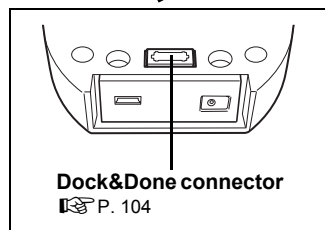
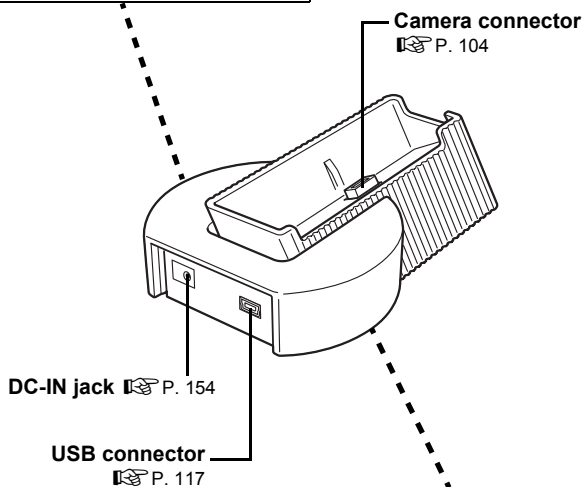
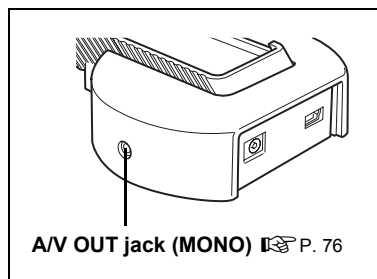







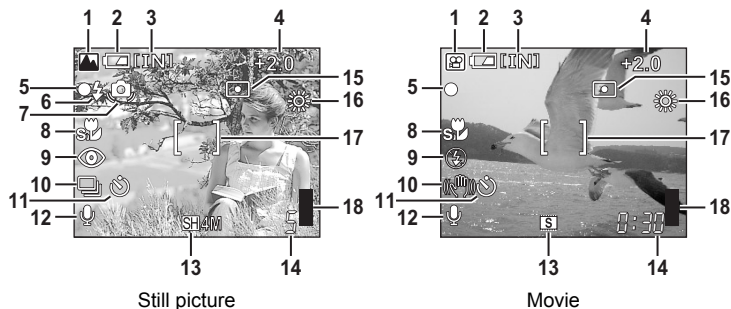









Monitor indications

Information regarding shooting or playback mode is displayed on the monitor. To adjust how much information to display in playback mode, select [DETAIL], [STANDARD], or [NO INFO] for the [INFO] setting.

● Shooting mode



	Item	Indications	Ref. page
1	Shooting mode	, etc.	P. 32
2	Battery check		—
3	Memory indicator	IN, xD	P. 28
4	Exposure compensation	-2.0 – +2.0	P. 45
5	Green lamp	○	P. 22
6	Flash stand-by Flash charge	(Lights) (Blinks)	P. 39 P. 39
7	Camera movement warning		—
8	Macro mode Super macro mode	 	P. 37 P. 37
9	Flash mode	() , , ,	P. 38
10	Sequential shooting (For still pictures) Image stabilizer (For movies)	 	P. 43 P. 41
11	Self-timer		P. 49

	Item	Indications	Ref. page
12	Sound record		P. 42, 54, 64
13	Record mode	 5M,  3M,  2M,  1M,  (for still pictures),  ,  (for movies)	P. 24
14	Number of storable still pictures	5	P. 25
	Remaining recording time	00:30	P. 40
15	Spot metering		P. 47
16	White balance	 ,  ,  , 	P. 46
17	AF target mark	[]	P. 22
18	Memory gauge	 ,  ,  , 	-

● Playback modes

Screens with [INFO] set to [DETAIL] are shown below. “Changing the amount of information displayed on the screen” (P.61)



Still picture

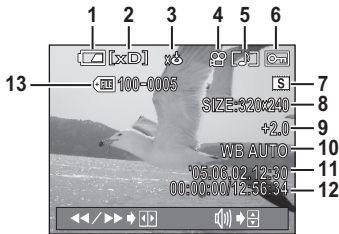

Movie

	Item	Indications	Ref. page
1	Battery check		—
2	Memory indicator	IN, xD,	P. 28
3	Store	(not store or complete store)	
4	Print reservation/ number of prints Movie	× 10 	P. 123 P. 59
5	Sound record		P. 59
6	PROTECT		P. 77
7	Record mode	[SH]5M, [H1]3M, [H2]2M, [B]1M, [X] (for still pictures), [S], [E] (for movies)	P. 24
8	Image size	2560 × 1920, 2048 × 1536, 1600 × 1200, etc.	P. 24
9	Exposure compensation	-2.0 – +2.0	P. 45
10	White balance	WB AUTO,	P. 46
11	Date and time	'05.12.11 15:30	P. 101
12	Frame number Playing time/Total recording time	5 00:00/00:36	P. 56, 85 P. 59
13	File number	FILE 100 – 0005	P. 56, 59

! Note

- The indications that appear on a movie picture that has been selected and displayed from the index display are different from those that appear when the movie picture is displayed using the movie playback function.

Index

For reference page numbers relating to camera parts, see “Names of parts”.

2 IN 1	52
DOCK MODE	112
Dock&Done	104

A

AV OUT jack	76
AC adapter	105, 110, 154
AF mode	48
AF target mark	22, 48, 177
Album	120
ALBUM ENTRY	82
ALL ERASE	108
ALL ERASE 	79
ALL IMAGES	120
ALL INDEX	120
ALL PRINT	120
ALL RESET	93
All-frame reservation 	126
AUTO (AF mode)	48
AUTO (flash)	38
AUTO (Metering)	47
Auto focus AF	23
Auto white balance	
WB AUTO	46
AV cable	76
AVAILABLE LIGHT PORTRAIT	
.....	34

B

BACKUP	78
BASIC 1M 	24
Battery	155
Battery check	176, 178
BEACH & SNOW 	33
BEEP	98
Beep sound 	98
BEHIND GLASS 	34
BLACK & WHITE	65
BLINDS (slideshow)	62
BRIGHTNESS	66, 67

C

CALENDAR	13, 57, 68, 70
----------------	----------------

Camera movement warning 	176
CANDLE 	33
Card	28
CCD	103, 159
CHECKERBOARD (slideshow)	62
CLOSE ALBUM	84
CLOSE CALENDAR	57
CLOSE STORAGE	107
Close-up playback 	56
Cloudy day 	46
COMPOSE IMAGE	68, 112
CREATE SHARE DISK	108
CUISINE 	33
CUSTOM BUTTON 	12, 96

D





Date and time 	101
DCF	159
DETAIL (INFO)	61
DIGITAL ZOOM	36
Direct printing	116
DOCUMENTS 	33
DPOF	123, 159

E



EDIT	65
EDIT (movie)	73
E-MAIL VGA 	24
END PLAYBACK	91
Erase 	13, 79, 87
Error messages	122, 145
EV	159
Exposure	22, 45
Exposure compensation 	45
EXTENDED (movie) 	25
EXTENDED (voice recording)	90

F



FADER (slideshow)	62
FILE NAME	99

File name 99, 121
 File No. 178
 Fill-in flash  38
 FINE (voice quality) 90
 FIREWORKS  32
 FIX IMAGE 66, 112
 Flash 38
 Flash charging 39
 Flash mode  12, 38
 Flash off  39
 Flash stand-by 39
 Fluorescent lamp  46
 Focus 22, 42
 Focus lock 22
 Folder name 99
 FORMAT 80
 FRAME 68
 FRAME MODE 53
 FULLTIME AF 42



H

HIGH 2M  24
 HIGH 3M  24

I



Image size 24, 159
 IMAGE STABILIZER  41
 INDEX 73, 74
 Index display  56
 INDEX PLAY 60
 INDOOR  32
 Internal memory 28

L



LANDSCAPE  32
 LANDSCAPE+PORTRAIT  32
 LAYOUT 68, 71
 Lithium ion battery 155

M

Macro  37
 MEMORY FORMAT 80
 METERING 47
 MODE MENU 17

MODE RESET 102
 MONITOR (voice recording) 90
 Monitor brightness
 adjustment  100
 Motion-JPEG 25
 MOVIE PLAYBACK  59
 Movie recording  40
 MULTI PRINT 120







N

























NEW ALL PRINT 114
 NIGHT SCENE  32
 NIGHT+PORTRAIT  32
 Noise reduction 34, 159
 NTSC 77, 160
 Number of storable still pictures
 25

O

OLYMPUS Master 130, 136
 Optical zoom 35

P

PAL 77, 160
 PANORAMA 50
 P-AUTO 32
 PC 135
 PictBridge 116
 Picture information (INFO) 61
 Picture rotation  58
 PIXEL MAPPING 103
 Pixels 24, 160
 Playback mode  10
 Playback on a TV 76
 PORTRAIT  33
 Press fully 23
 Press halfway 22
 PRINT 120
 PRINT  13, 112, 124
 PRINT AND 114
 PRINT IMAGE 112
 PRINT ORDER 120
 PRINT ORDER  112, 117
 Print settings  123
 Protect  77

- R**
- RANDOM (slideshow) 62
 - REARRANGE 85
 - REC VIEW 99
 - Record mode  24, 27
 - Recording sound 
 - 42, 54, 64, 89
 - Recording sound with movies 
 - 42
 - Recording sound with still pictures  54
 - REDEYE FIX 66, 67
 - Red-eye reduction flash  38
 - Remaining recording time 25
 - Remote control 76
 - Resizing  65
- S**
- SATURATION 66, 67
 - SCENE 12, 32
 - SCREEN 94
 - SCROLL (slideshow) 62
 - SEL. ALBUM 13, 84
 - SEL. PRINT 117
 - Selecting a language  94
 - Self Portrait  33
 - Self-timer  12, 49
 - SEPIA 65
 - Sequential shooting  43
 - SETUP 168
 - Shooting mode 10
 - SHUTTER SOUND 98
 - Shutter speed 32
 - Single-frame erase  79, 87
 - Single-frame playback 56
 - Single-frame reservation  124
 - SLEEP (sleep mode) 95, 160
 - Slideshow  62
 - Soft flash () 38
 - SPORT  33
 - SPOT (AF mode) 48
 - Spot metering  47
 - STANDARD (INFO) 61
 - STANDARD (slideshow) 62
 - STANDARD (voice quality) 90
 - STANDARD  25
 - STOP (movie playback) 59
 - STORAGE 107
 - STORE 113
 - STORE AND 113
 - Sunny day  46
 - SUNSET  33
 - SUPER HIGH 5M  24
 - Super macro shooting  37
 - SWIVEL (slideshow) 62
- T**
- TITLE 68, 69
 - Top menu 15
 - Trimming  65, 66
 - Tungsten light  46
- U**
- UNDO ALL 86
 - UNDO ENTRY 86
 - USB 112, 116
 - USB cable 112, 116, 135
 - USB driver 131, 143
- V**
- VIDEO OUT 77
 - VIVID  34
 - VOICE QUALITY 90
 - VOICE REC 89
 - VOICE REC. END 89
 - VOLUME 98
- W**
- White balance WB 46
- X**
- xD-Picture Card 29
- Z**
- Zoom 35
 - ZOOM DOWN (slideshow) 62
 - ZOOM UP (slideshow) 62

OLYMPUS®

<http://www.olympus.com/>

OLYMPUS IMAGING CORP.

Shinjuku Monolith, 3-1 Nishi-Shinjuku 2-chome, Shinjuku-ku, Tokyo, Japan

OLYMPUS IMAGING AMERICA INC.

Two Corporate Center Drive, P.O. Box 9058, Melville, NY 11747-9058, U.S.A. Tel. 631-844-5000

Technical Support (USA)

24/7 online automated help: <http://www.olympusamerica.com/support>

Phone customer support: Tel. 1-888-553-4448 (Toll-free)

Our phone customer support is available from 8 am to 10 pm

(Monday to Friday) ET

E-Mail: distec@olympus.com

Olympus software updates can be obtained at: <http://www.olympus.com/digital>

OLYMPUS EUROPA GMBH

Premises: Wendenstrasse 14-18, 20097 Hamburg, Germany

Tel: +49 40-23 77 3-0 / Fax: +49 40-23 07 61

Goods delivery: Bredowstrasse 20, 22113 Hamburg, Germany

Letters: Postfach 10 49 08, 20034 Hamburg, Germany

European Technical Customer Support:

Please visit our homepage <http://www.olympus-europa.com>

or call our TOLL FREE NUMBER* : **00800 - 67 10 83 00**

for Austria, Belgium, Denmark, Finland, France, Germany, Italy, Luxemburg, Netherlands,
Norway, Portugal, Spain, Sweden, Switzerland, United Kingdom

* Please note some (mobile) phone services/provider do not permit access or request an
additional prefix to +800 numbers.

For all not listed European Countries and in case that you can't get connected

to the above mentioned number please make use of the following

CHARGED NUMBERS: **+49 180 5 - 67 10 83** or **+49 40 - 237 73 899**

Our Technical Customer Support is available from 9 am to 6 pm MET (Monday to Friday)